

Illuminazione / Lighting_

EXPERIMENT	08 ¹⁵
FARETTO	16 ¹⁹
FLIP	20 ²⁵
GONG	26 ⁴⁹
(DA PARETE / WALL)	26 ³⁷
(DA TAVOLA / TABLE)	38 ⁴³
(DA TAVOLA / WORK)	44 ⁴⁹
MUSH	50 ⁵⁹
NEXT	60 ⁶⁷

Oggetti / Objects_

MARRAKECH	68 ⁷⁵
SEA SIDE	76 ⁹⁵
(COFFEE TABLES)	76 ⁷⁹
(LIBRERIA / BOOK CASE)	80 ⁸⁹
(SCRIVANIA / DESK)	90 ⁹⁵

Informazione Technice / Technical Information_	96 ¹²¹
---	--------------------------

Vesta Design_	122 ¹²³
Palomba Serafini Associati_	124 ¹²⁵

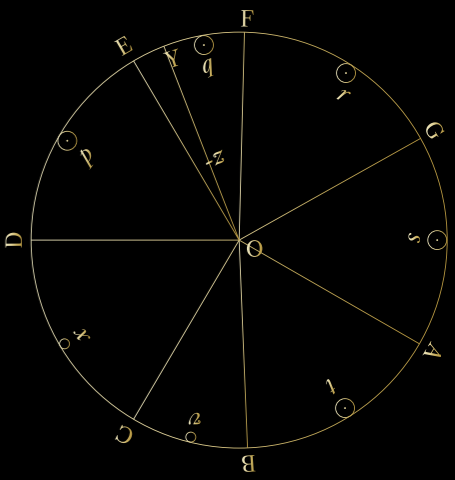

**Lighting
and Design
Objects for
every space
and every
occasion.**

Experiment_lampada da tavolo / table lamp

ITA Porta fiore luminoso in cristallo acrilico da 60 mm frutto della collaborazione con Graftonica, spin off Università Bicocca di Milano, con base in alluminio super mirror.



To join with-
out imper-
fections

08

60

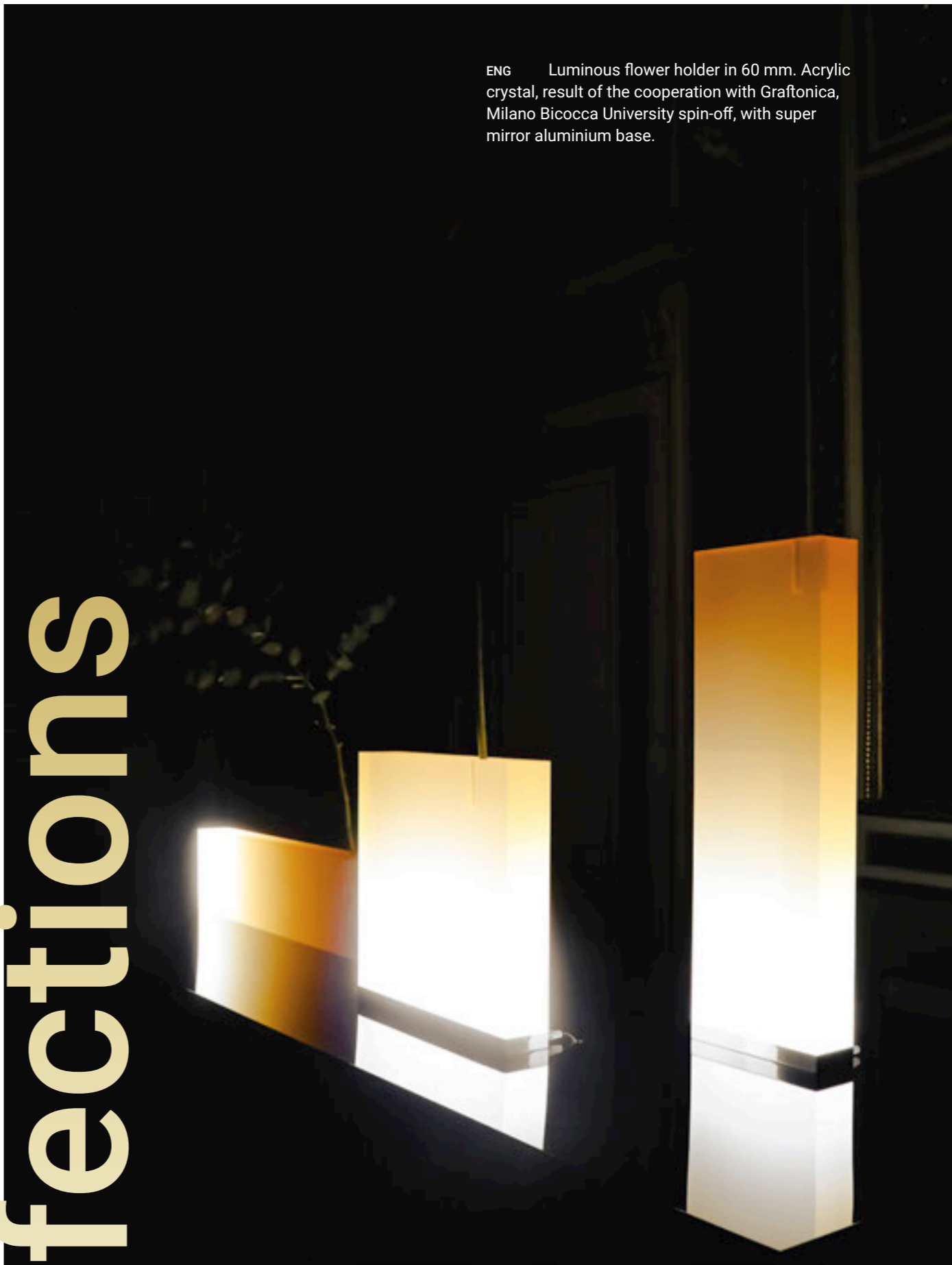

ENG Luminous flower holder in 60 mm. Acrylic crystal, result of the cooperation with Graftonica, Milano Bicocca University spin-off, with super mirror aluminium base.



08148



08148



08148

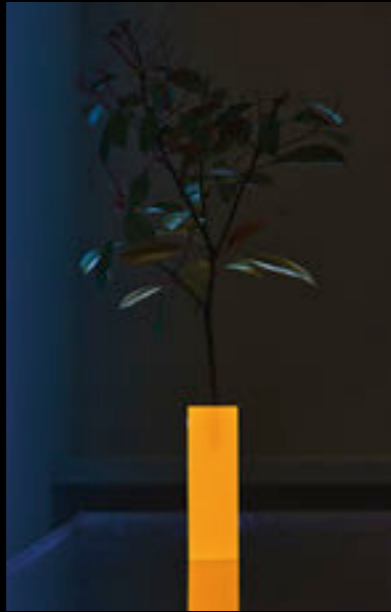

08149



08149



08148 08127 08149

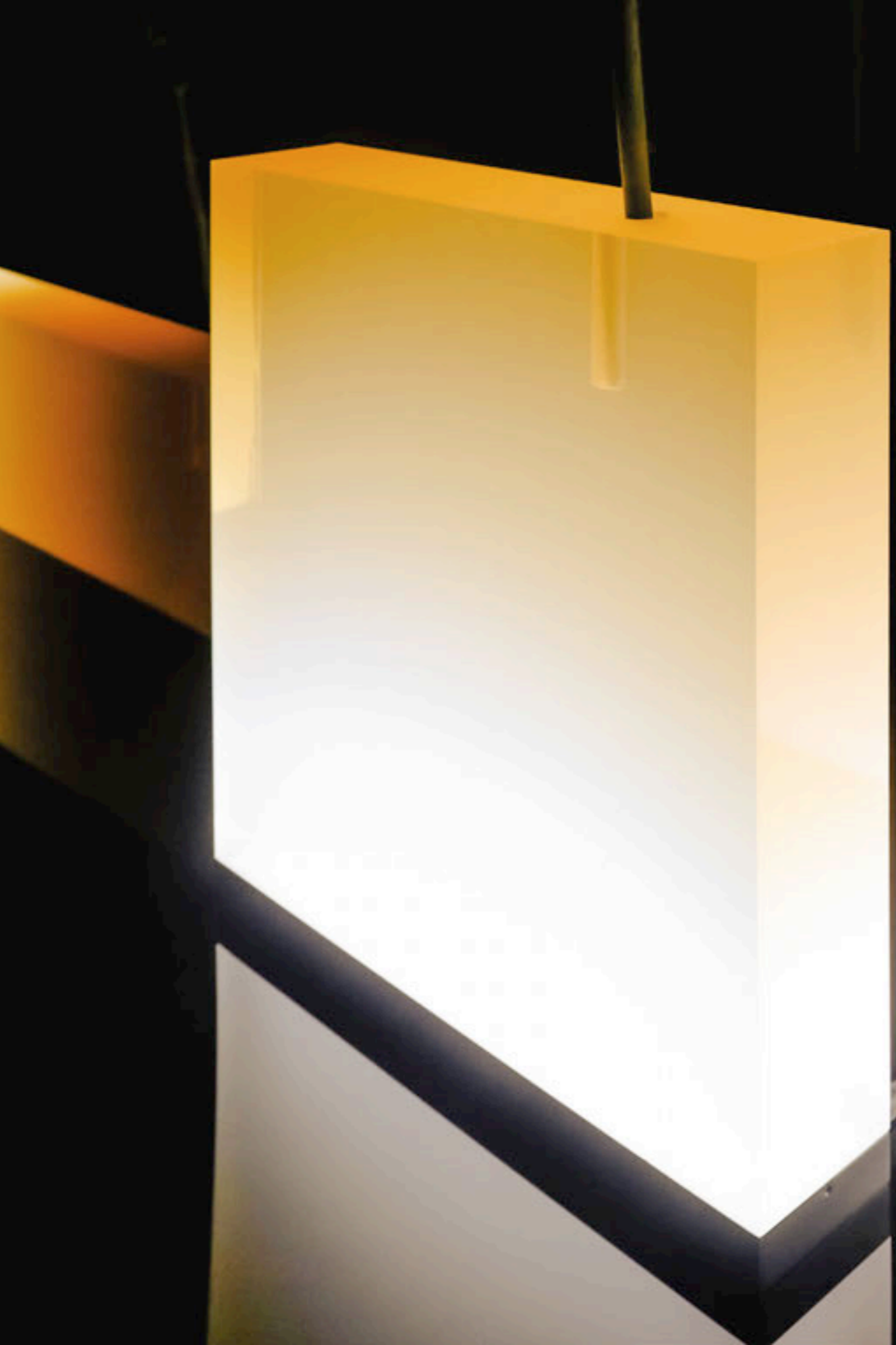

012

013 EXPERIMENT – LAMPADA DA TAVOLO / TABLE LAMP

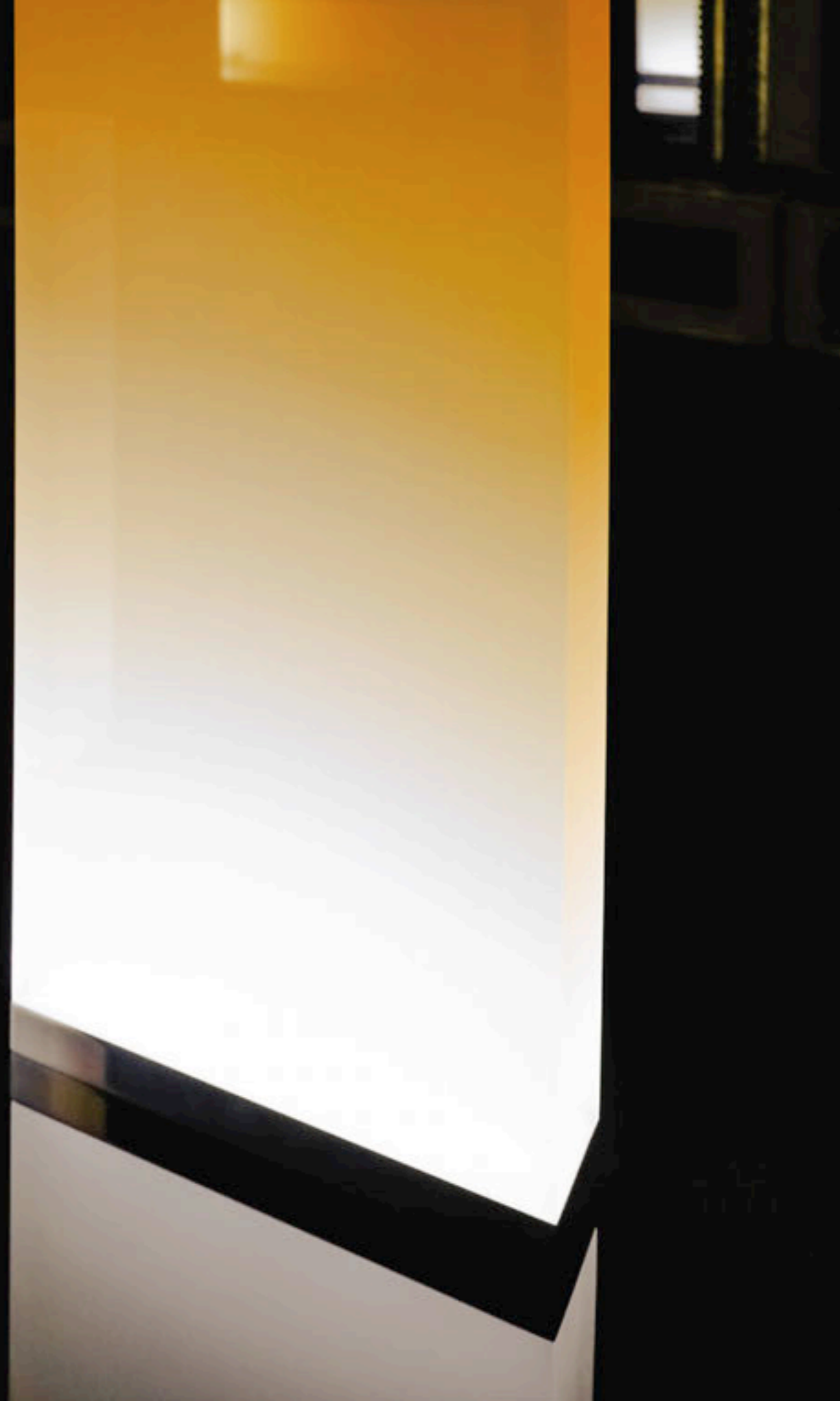



015 EXPERIMENT - LAMPADA DA TAVOLO / TABLE LAMP

THREE PARALLELEPIPEDS OF OPALESCENT MATERIAL WITH MINIMAL MILLING TO ACCOMMODATE A SINGLE FLOWER. WHEN ILLUMINATED, THE THREE VASES BECOME OPALS OF A SHADED COLOR THAT GOES FROM MILKY TO GOLDEN DEPENDING ON THE DISTANCE FROM THE LIGHT SOURCE. THIS GRADUAL COLORING OF THE LIGHT GIVES THE OBJECT A POETIC AURA.

LUDOVICA SERAFINI AT 'IPERTESTO', THE EXHIBITION THAT CELEBRATED THE TWENTY-FIFTH ANNIVERSARY OF PALOMBA SERAFINI ASSOCIATI WITH UNIQUE PIECES OF FURNITURE, DESIGNED IN COLLABORATION WITH LEADING ITALIAN AND INTERNATIONAL DESIGN COMPANIES.



TRE PARALLELEPIPEDI DI MATERIALE OPALESCENTE CON UNA MINIMA FRESATURA PER ACCOGLIERE UN SOLO FIORE. QUANDO ILLUMINATI I TRE VASI DIVENTANO OPALI DI COLORE SFUMATO CHE PASSA DAL LATTIGINOSO AL DORATO A SECONDA DELLA DISTANZA DALLA FONTE LUMINOSA. QUESTA COLORITURA GRADUALE DELLA LUCE CONFERISCE ALL'OGGETTO UN'AUREA POETICA DI PRESENZA A SÉ STANTE.

LUDOVICA SERAFINI ALLA MOSTRA 'IPERTESTO', L' ALLESTIMENTO CHE HA CELEBRATO IL VENTICINQUESIMO ANNIVERSARIO DELLO STUDIO PALOMBA SERAFINI ASSOCIATI CON MOBILI UNICI, PROGETTATI IN COLLABORAZIONE CON LE PIU IMPORTANTI AZIENDE DI DESIGN ITALIANE E INTERNAZIONALI.

Faretto _ lampada da tavolo/table lamp

ITA lampada da tavolo composta da una base in cristallo acrilico trasparente e da un cilindro in metallo verniciato che funge da diffusore.



016

**Cylindrical,
discreet and
perfectly
balanced.**

017

ENG Table lamp composed of a base in transparent acrylic crystal and a painted metal cylinder that acts as a diffuser.

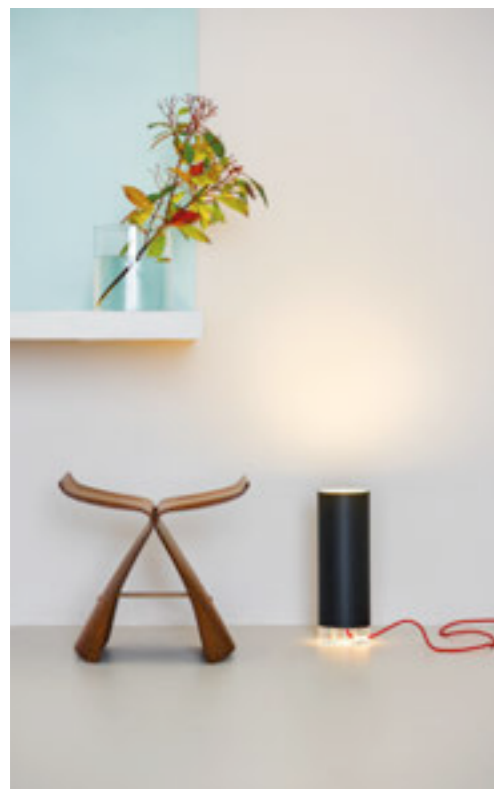

08120

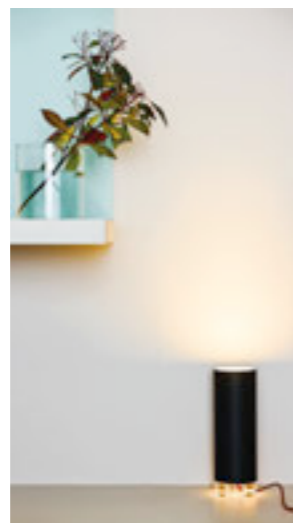

08120



08120

018

019 FARETTO – LAMPADA DA TAVOLO / TABLE LAMP



Flip _ lampada a sospensione o da tavolo /suspension and table lamp

ITA Lampada da tavolo e sospensione in: Acciaio inox super mirror trattato con smalto acrilico anti-touch. Cristallo acrilico light diffuser.



020

Essential, refined aesthetics and innate elegance.

021

ENG Table lamp and suspension lamp available in: Super mirror stainless steel treated with anti-touch acrylic enamel. Light diffuser acrylic crystal.

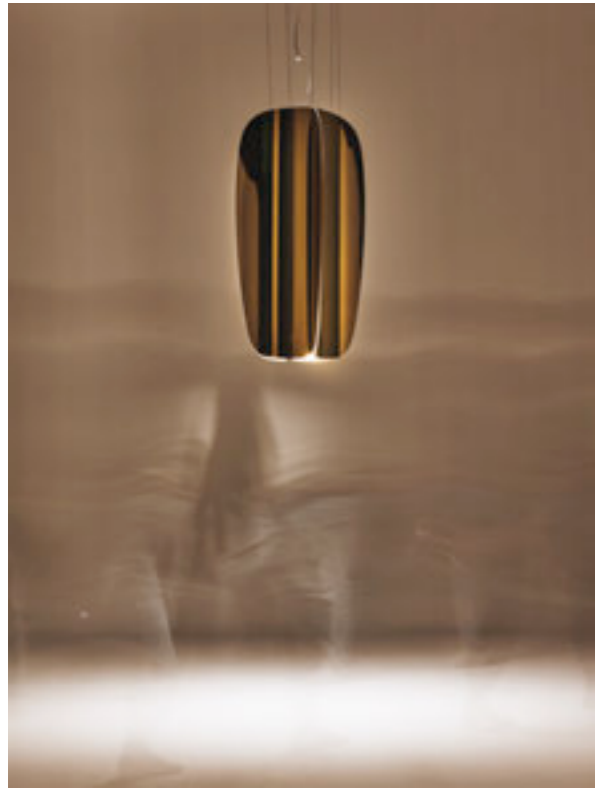

08143



08145



08143

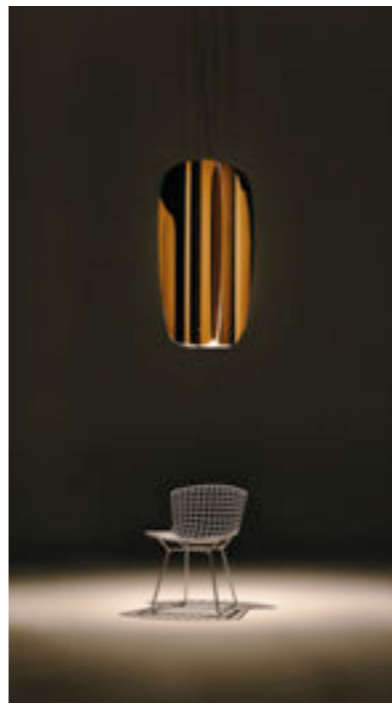

08143



08145

023 FLIP – LAMPADA A SOSPENSIONE O DA TAVOLO / SUSPENSION AND TABLE LAMP

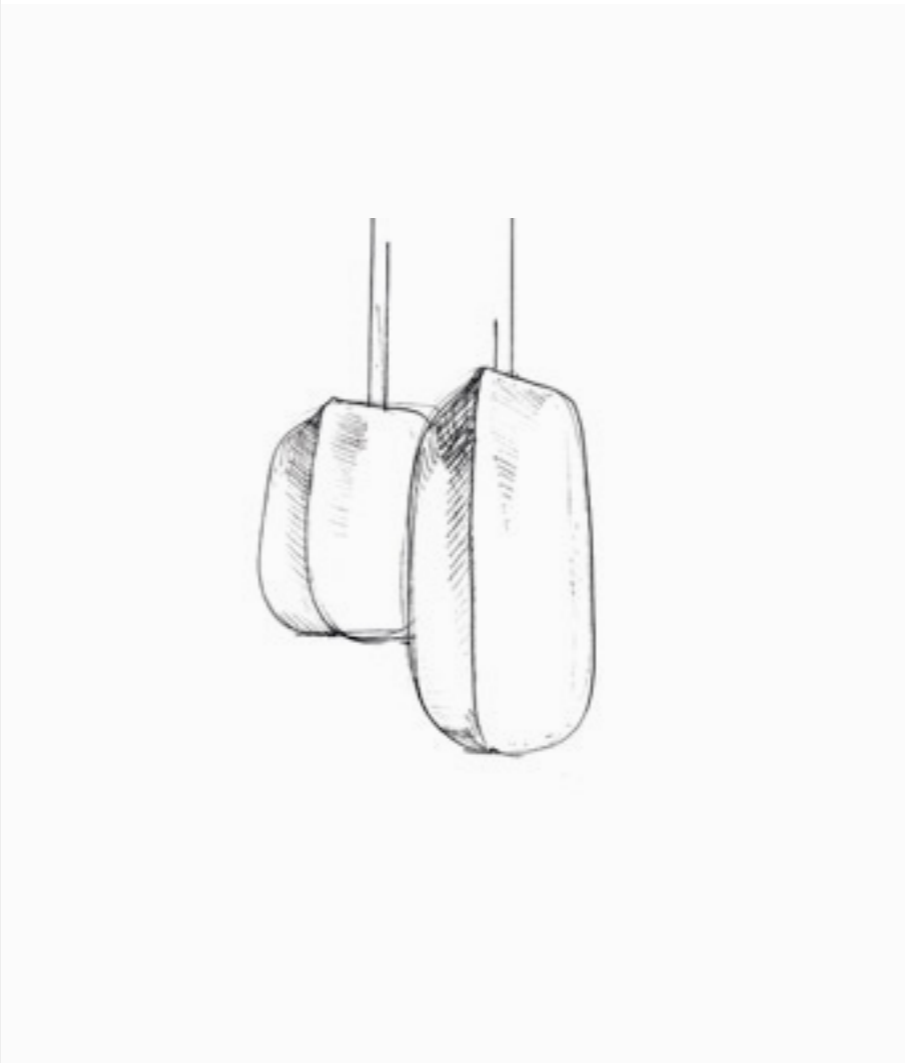

08142

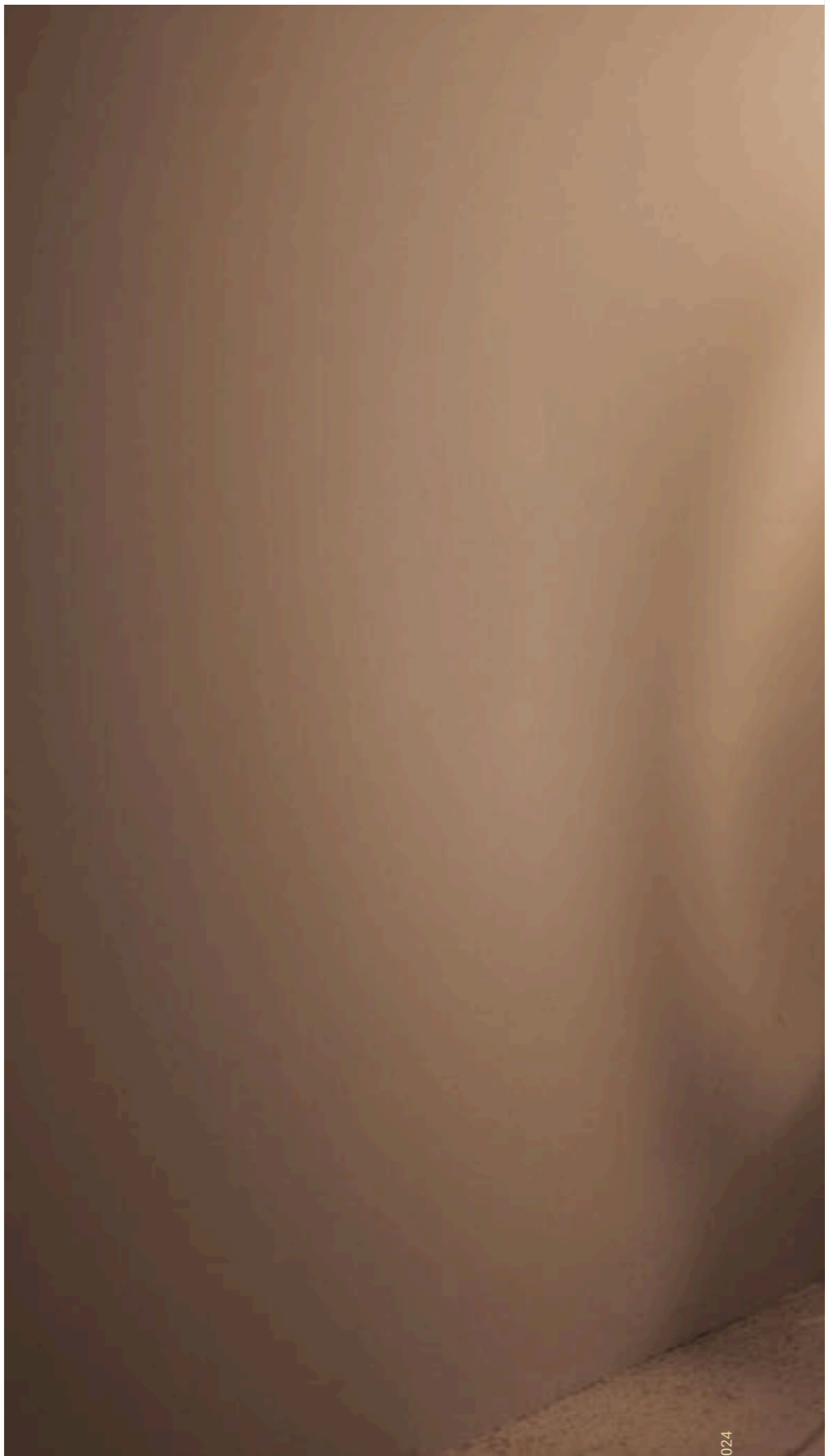

025 FLIP – LAMPADA A SOSPENSIONE E DA TAVOLO / SUSPENSION AND TABLE LAMP



026

Designed for peace and mind- fulness.

027





08134

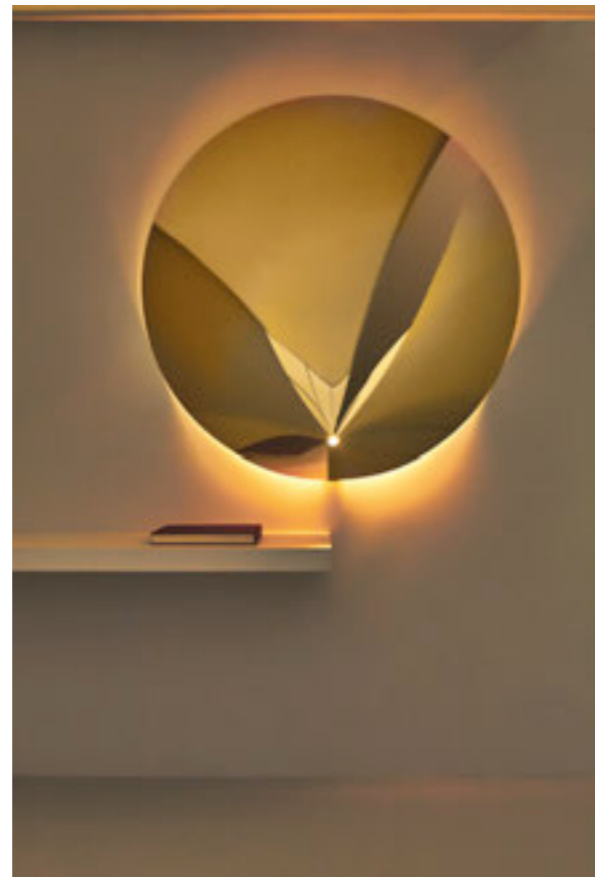

08134

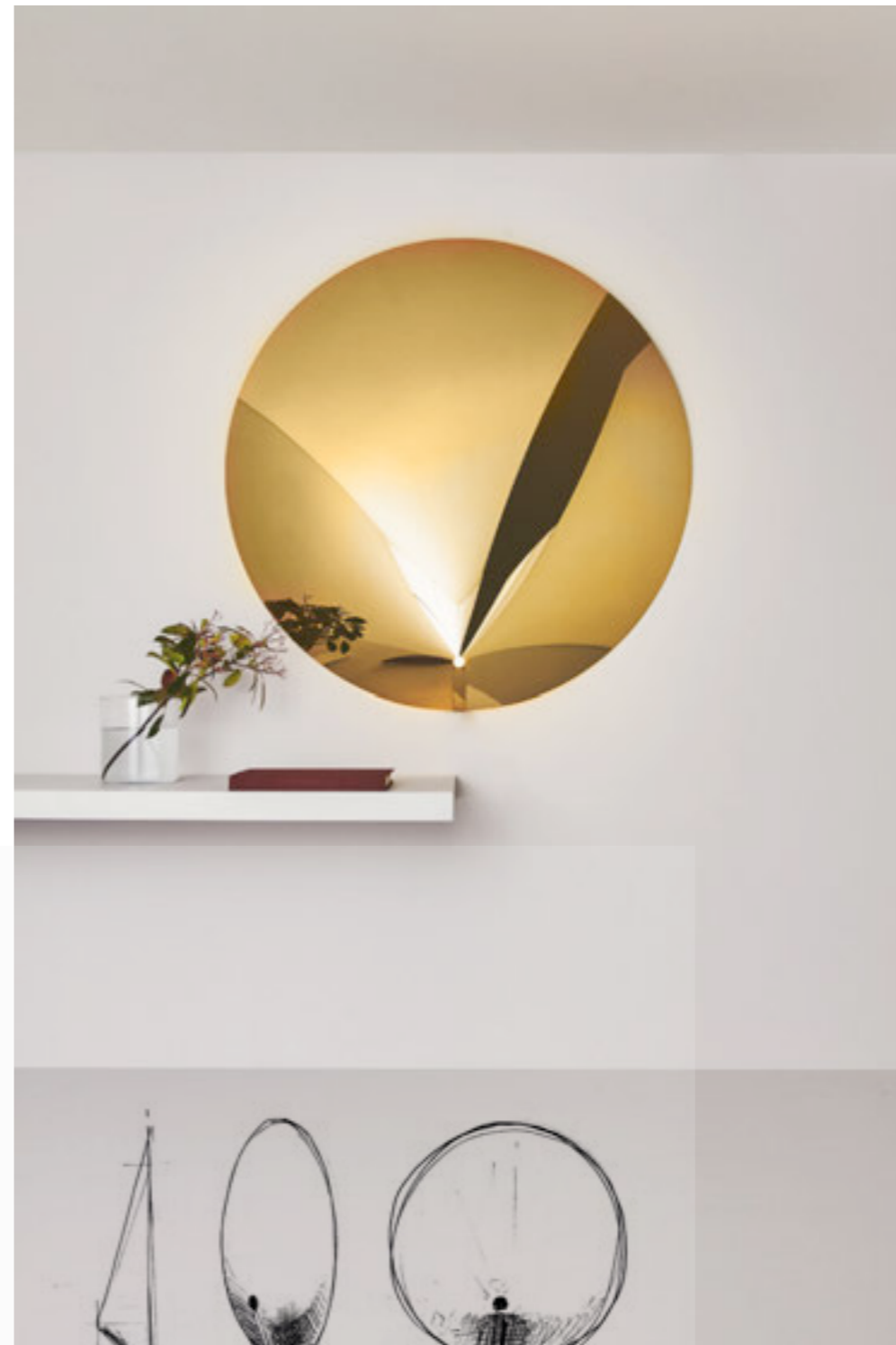

08134



08134

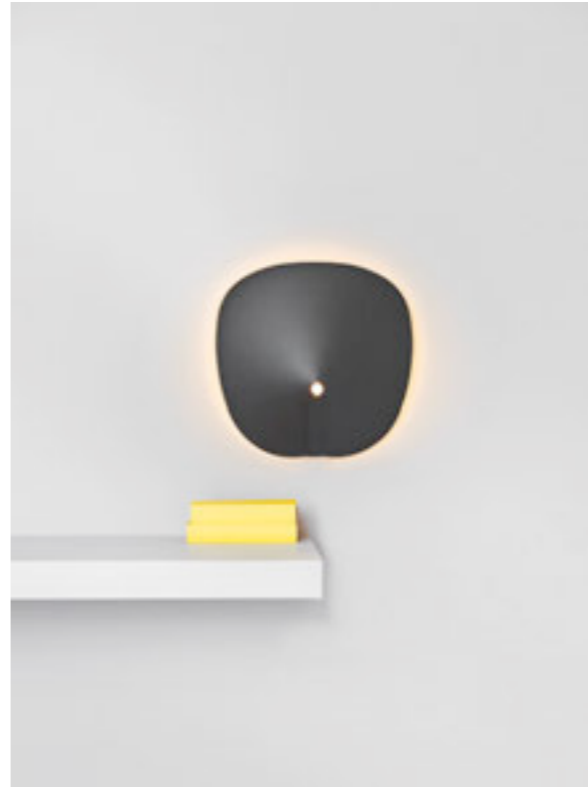

08135

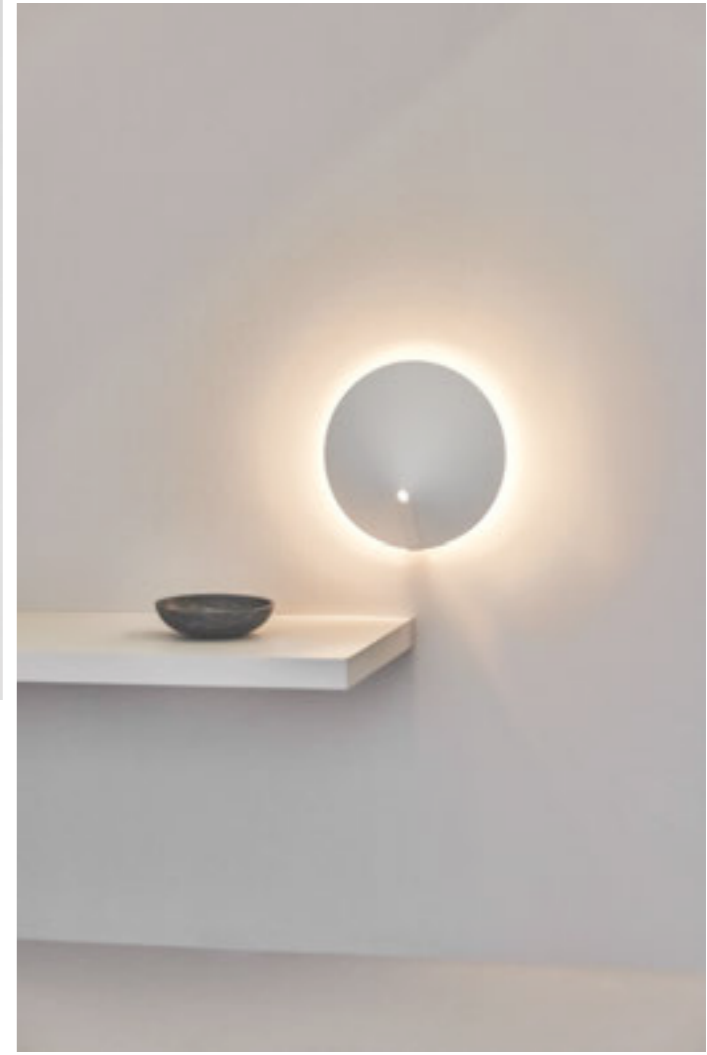

08132



034

035 GONG – LAMPADA DA PARETE / WALL LAMP





ACCIAIO SUPERMIRROR TAGLIATO A LASER E VERNICIATO IN FINITURA ORO E SUCCESSIVAMENTE CON UNA SFUMATURA ROSSA. LA LASTRA DI ACCIAIO VIENE TAGLIATA IN PIANO CON FORMA TONDA. IL FORO E LO SPICCHIO TAGLIATI SONO DECENTRATI RISPETTO AL CENTRO DELLA CIRCONFERENZA. VIENE POI RICHIUSA SU PERNI PRE-POSIZIONATI. IL RISULTATO È UN GRANDE CONO SPECCHIANTE CON IL CENTRO DISASSATO E COLORITURE DORATE.

ROBERTO PALOMBA CON ROSSANA ORLANDI IN VISITA AD 'IPERTESTO', LA MOSTRA CHE HA CELEBRATO IL VENTICINQUESIMO ANNIVERSARIO DELLO STUDIO PALOMBA SERAFINI ASSOCIATI CON MOBILI UNICI, PROGETTATI IN COLLABORAZIONE CON LE PIÙ IMPORTANTI AZIENDE DI DESIGN ITALIANE E INTERNAZIONALI.

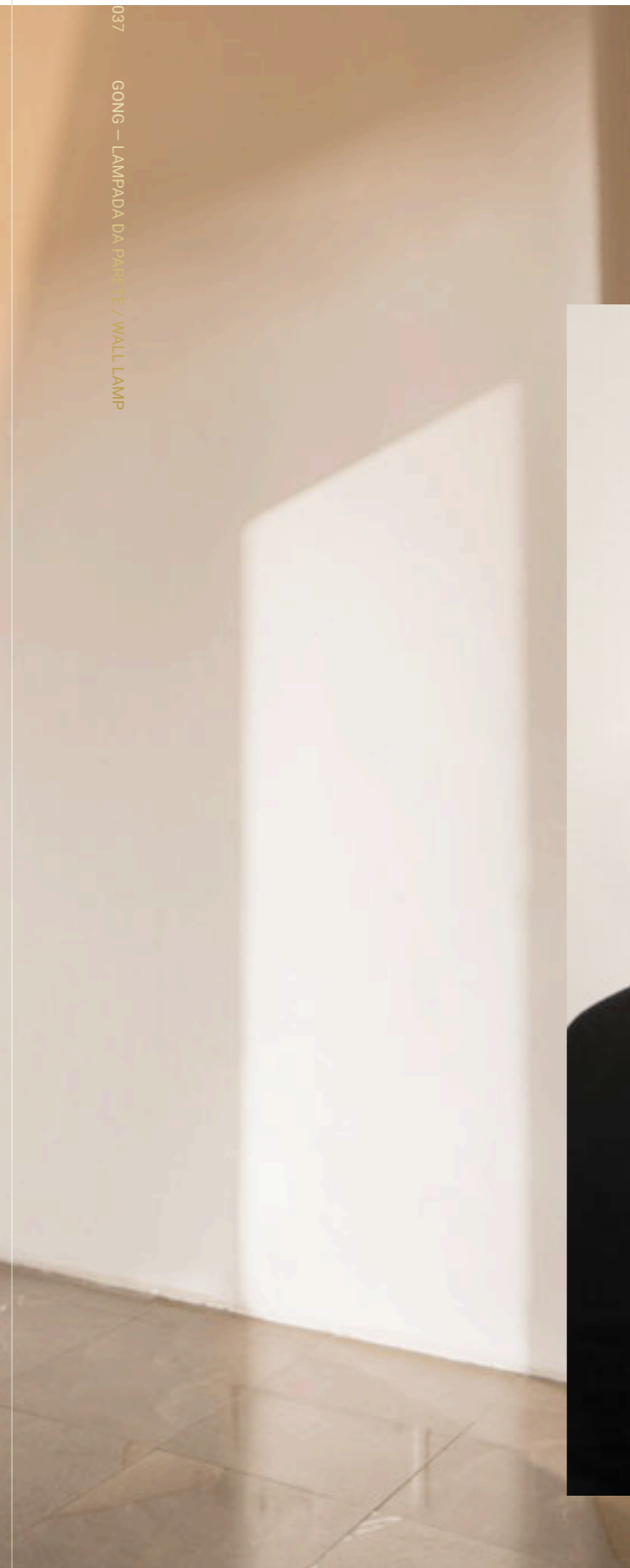

SUPERMIRROR STEEL LASER CUT AND PAINTED IN GOLD FINISH AND THEN WITH A RED SHADE. THE STEEL PLATE IS CUT FLAT WITH A ROUND SHAPE. THE HOLE AND THE SLICE ARE OFF-CENTER IN RELATION TO THE CENTER OF THE CIRCUMFERENCE. IT IS THEN CLOSED ON PRE-POSITIONED PINS. THE RESULT IS A LARGE MİRRORED CONE WITH AN OFFSET CENTER AND GOLDEN HUES.

BELOW, ROBERTO PALOMBA WITH ROSSANA ORLANDI AT 'IPERTESTO', THE EXHIBITION CELEBRATES THE TWENTY-FIFTH ANNIVERSARY OF PALOMBA SERAFINI ASSOCIATI WITH UNIQUE PIECES OF FURNITURE, DESIGNED IN COLLABORATION WITH LEADING ITALIAN AND INTERNATIONAL DESIGN COMPANIES





Great things
come in
small pack-
ages.

038

630



08137



08137



08137

041 GONG – LAMPADA DA TAVOLO / TABLE LAMP

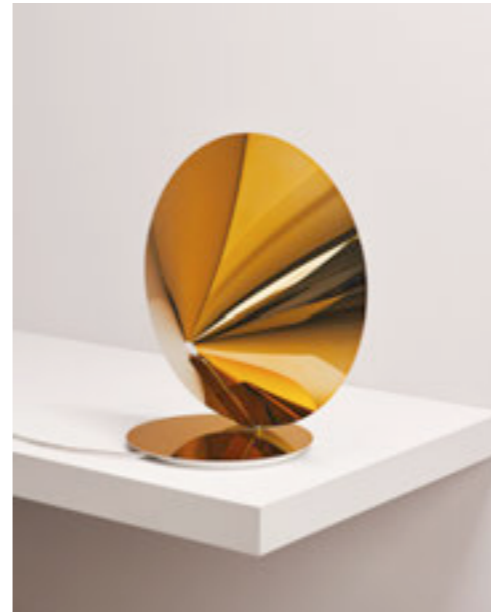

08137

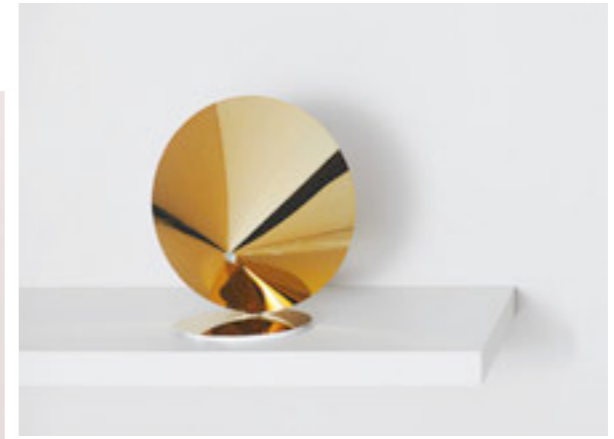

08137

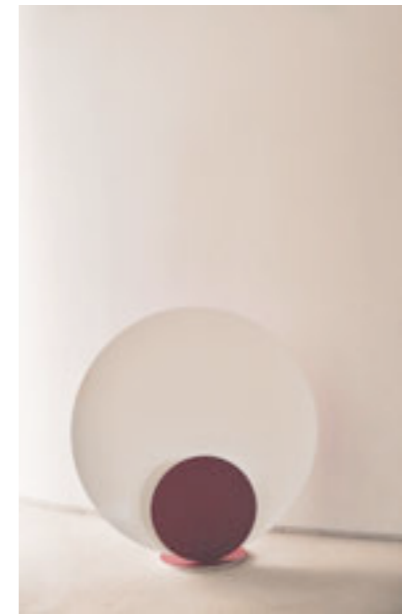

08137



08137



042

043 GONG – LAMPADA DA TAVOLO / TABLE LAMP



ITA Lampada da tavolo che si inserisce nella famiglia dalle combinazioni inaspettate. Una lampada con una forma tridimensionale e dal rigore formale, finiture affascinanti, cromature e dorature capaci di produrre effetti unici, le verniciature da un touch "made in Vesta" capaci di rendere setose le superfici.



**Unexpected combinations,
three-dimensional
and, formal
rigor.**

044

045

ENG Table lamp that fits into the family of unexpected combinations. A lamp with a three-dimensional shape and formal rigor, charming finishes, chrome and gold that can produce unique effects, the painting by a touch "made in Vesta" able to make silky surfaces.

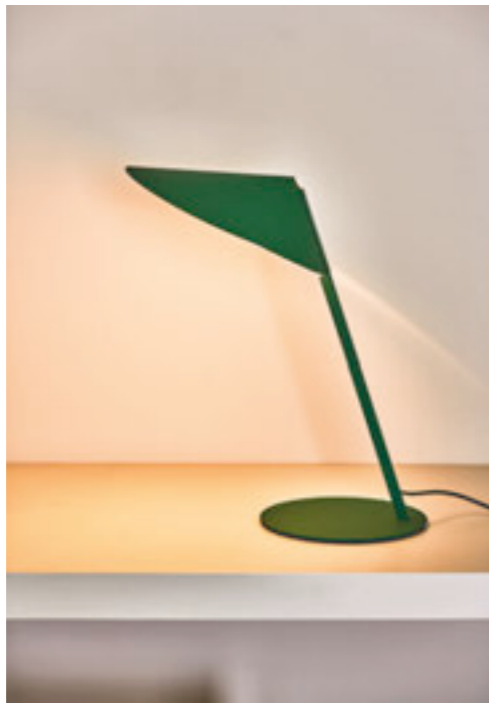

01950



01950

047 GONG WORK – LAMPADA DA TAVOLO / TABLE LAMP

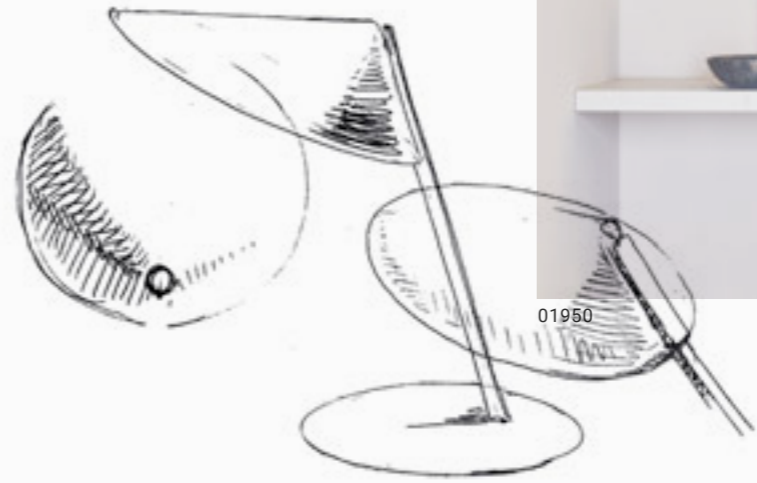

01950





048

049 GONG WORK – LAMPADA DA TAVOLO / TABLE LAMP



Mush__lampada da tavolo / table lamp

ITA Una luce nomade, un oggetto che riprende il tema della candela “tecnologica”, una piccola lampada ricaricabile da mettere sopra un tavolo, sopra un comodino come a terra sul bordo di una stanza, capace di creare una luce soffusa ed accogliente.

Mush è un oggetto semplice, rigoroso e minimale, caratterizzato da geometrie pure e da una diffusione di luce che si propaga sulla parte inferiore della lampada e sulla sua superficie.



050

Pure geometries and diffusion of light.

051

ENG A nomadic light, an object that takes up the theme of the “technological” candle, a small rechargeable lamp to put on a table, on a bedside table as if on the ground on the edge of a room, able to create a soft and welcoming light.

Mush is a simple, rigorous and minimal object, characterized by pure geometries and by a diffusion of light that spreads on the lower part of the lamp and on its surface.



01945

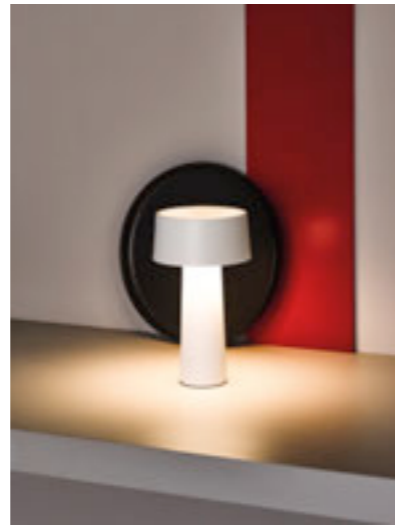

01945



01945

053

MUSH – LAMPADA DA TAVOLO / TABLE LAMP

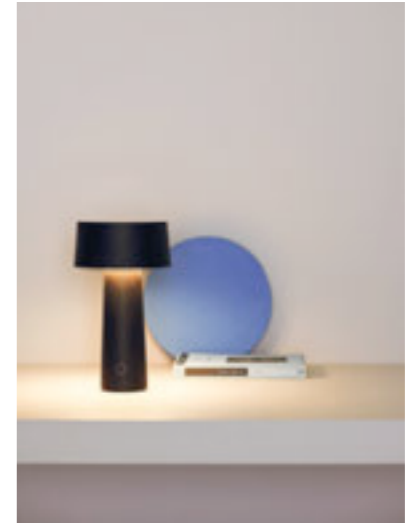

01945



01945



01945



01945



01945

055 MUSH – LAMPADA DA TAVOLO / TABLE LAMP



054





01945



01945



01945

059 MUSH – LAMPADA DA TAVOLO / TABLE LAMP



- ITA Lampada a sospensione in:
- Cristallo acrilico light diffuser
 - Cristallo acrilico gold minor
 - Cristallo acrilico trasparente

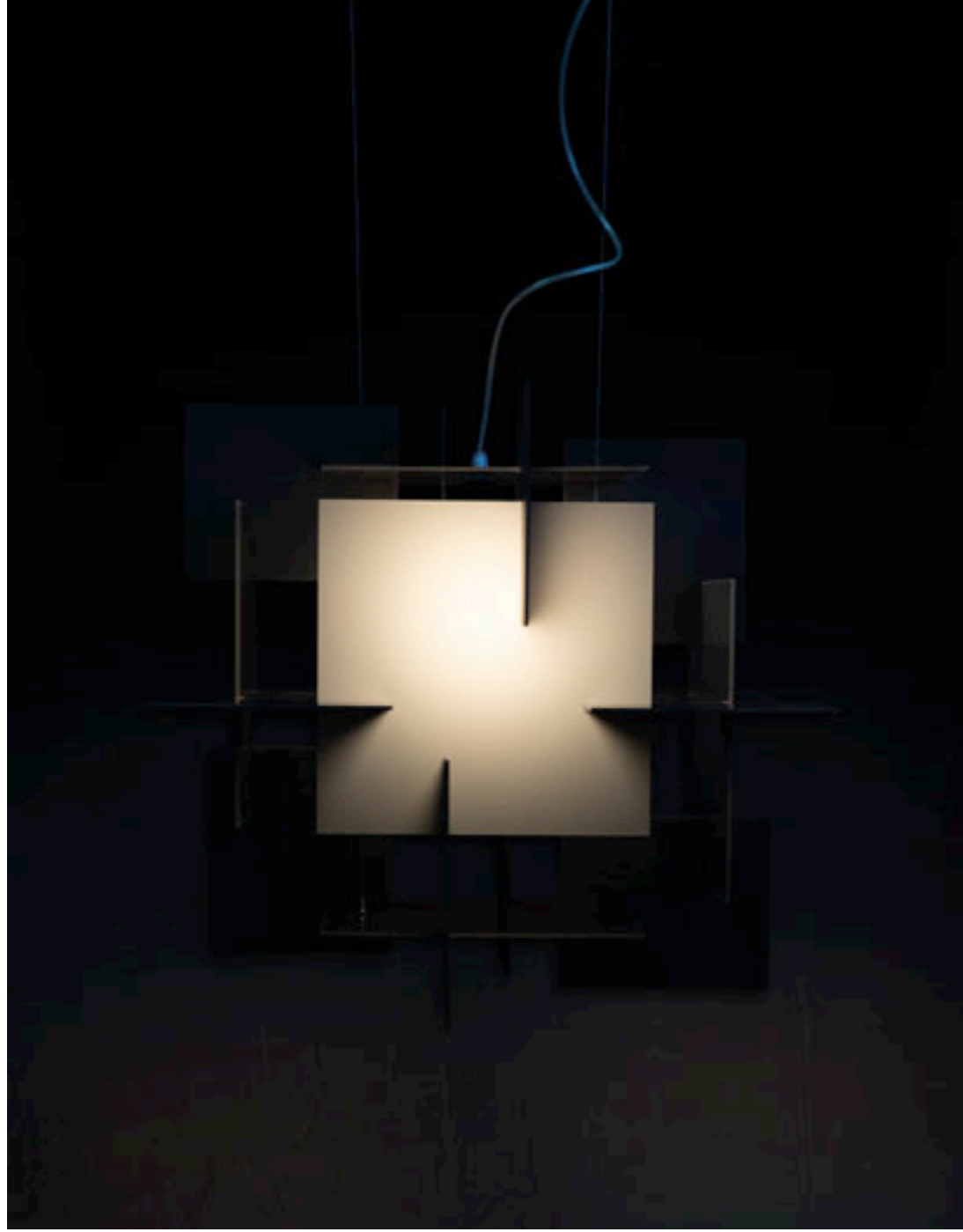

060

Precision and beauty, form and function.

061

- ENG Acrylic crystal suspension lamp
available in three versions:
- Light diffuser acrylic crystal
 - Gold mirror acrylic crystal
 - Transparent acrylic crystal



08210 05



08210 05

063 NEXT - LAMPADA A SOSPENSIONE / SUSPENSION LAMP

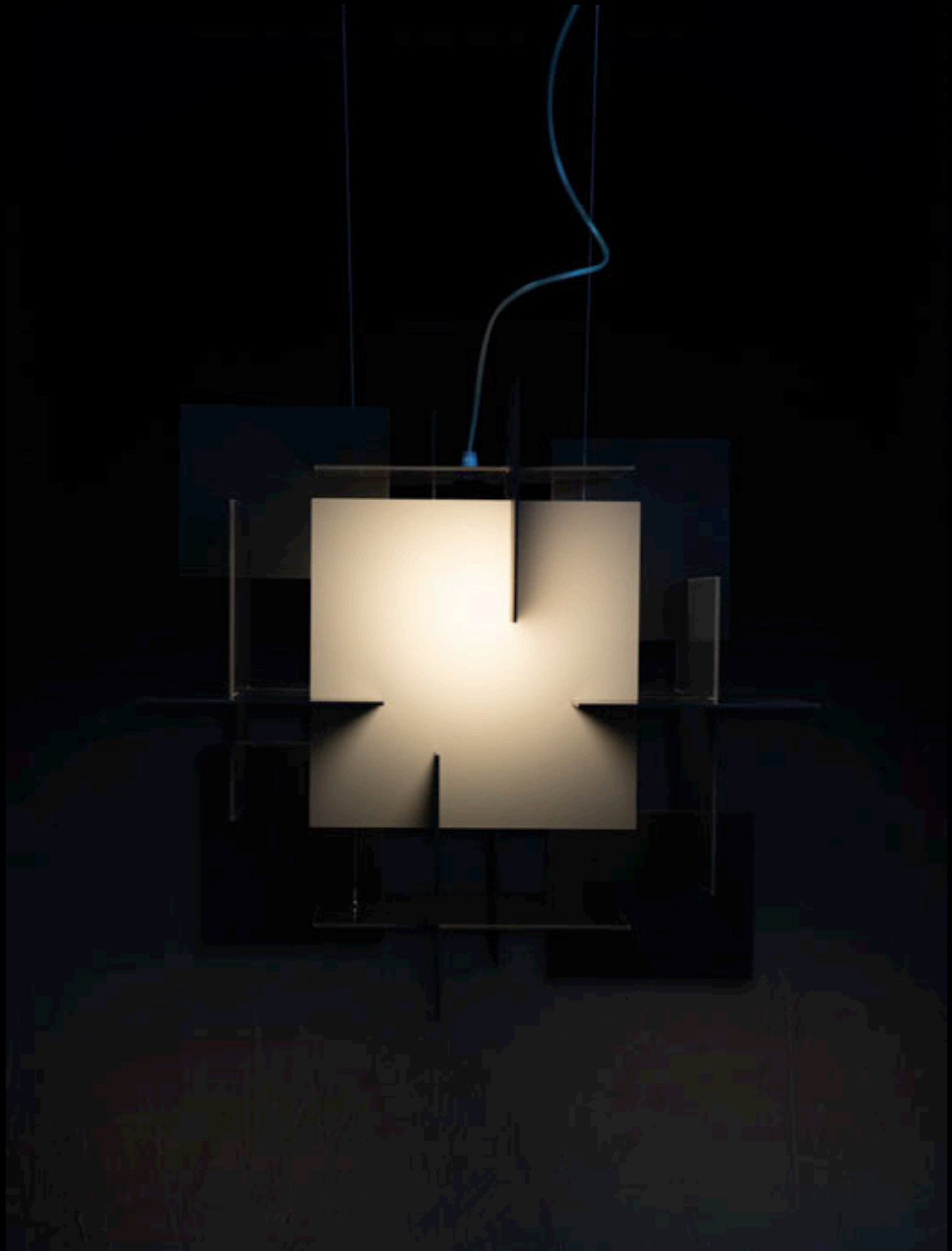



08210 05

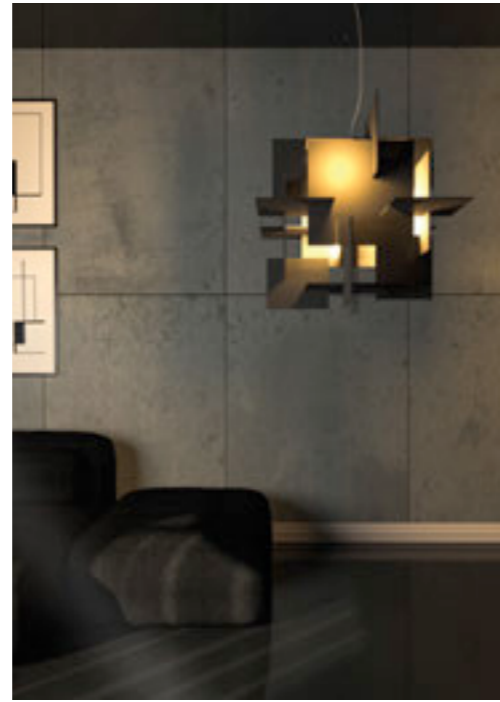

08210 05

065 NEXT - LAMPADA A SOSPENSIONE / SUSPENSION LAMP



08210 56



067 NEXT - LAMPADA A SOSPENSIONE / SUSPENSION LAMP

ITA Tavoli dotati di superfici decorate, caratterizzate da finiture originali che rendono questi oggetti estremamente affascinanti senza mai scadere nel barocco. Una collezione nata dallo studio delle decorazioni e dalla voglia di portare colori unici in ambienti minimali.



068

Born from the study of decorations and desire.

ENG Tables with decorated surfaces, characterized by original finishes that make these objects extremely fascinating without ever falling into the baroque. A collection born from the study of decorations and the desire to bring unique colors in minimal environments.

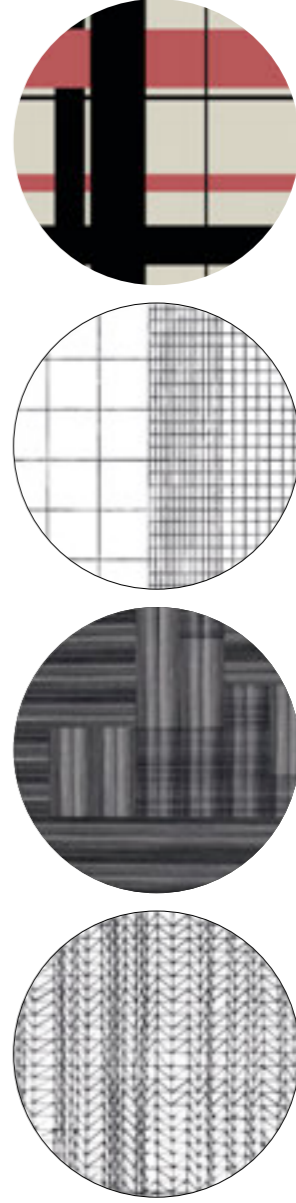



104 96 06FP 102 96 96



103 96 96 104 96 06FP

071

MARRAKECH – COFFEE TABLE



102 10 10



102 10 10



102 10 10

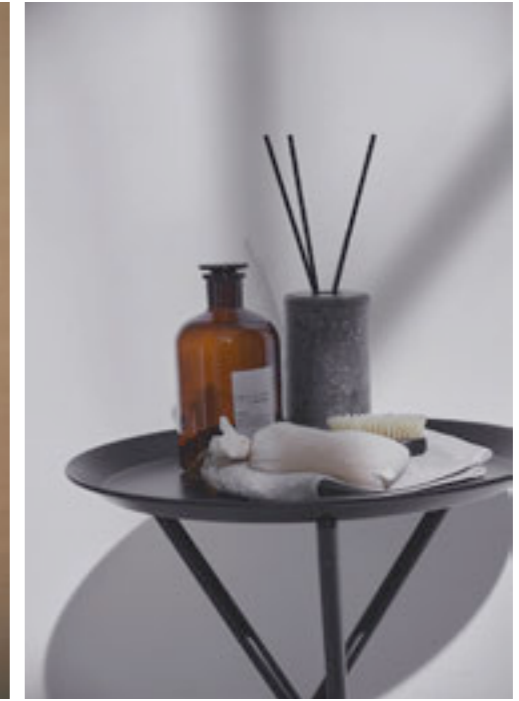

102 10 10

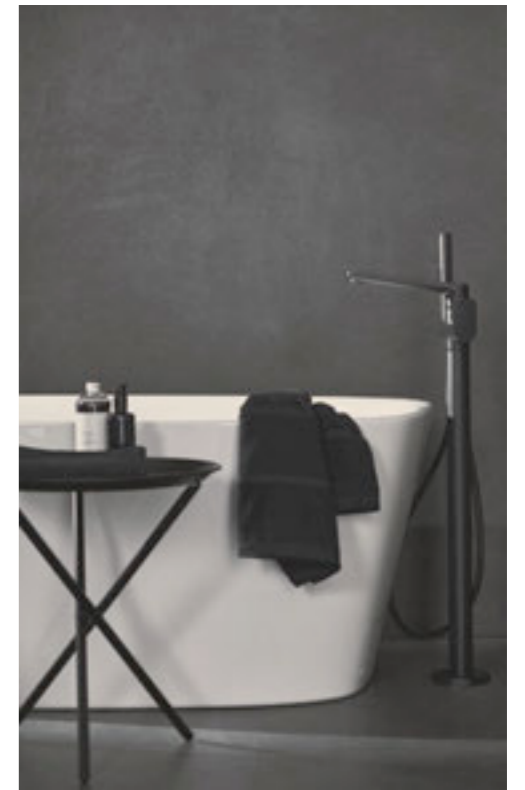

102 10 10

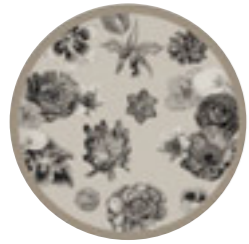
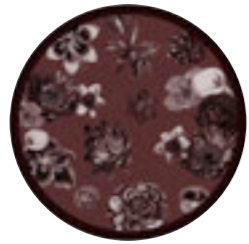
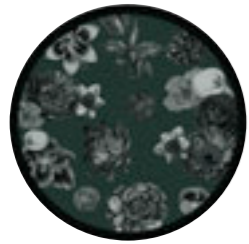
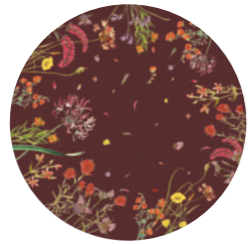

075
MARRAKECH – COFFEE TABLE

Sea Side__coffee table

ITA Struttura portante in tubolare quadrato in metallo 15 × 15 mm verniciata con ripiani in cristallo acrilico trasparente spessore 15 mm.

I coffee table, sia circolari che quadrati, alla base avranno alloggiato un pannello finitura specchio.



Tables for any
space, made
to blend into
every home.

076

077



ENG Metal coated structure in square tube 15 × 15 mm with shelves in transparent acrylic crystal 15 mm thickness.

Both round and square coffee tables will have a sheet with a mirror finish at the base.



04213



04212

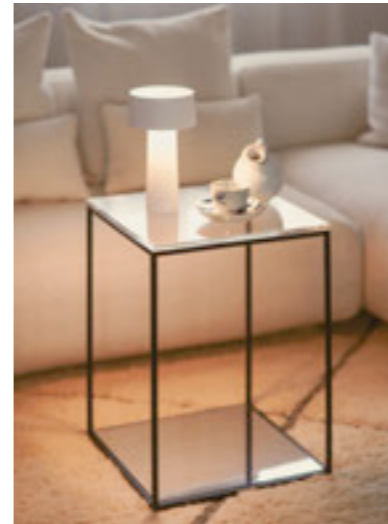

04213



04213



04212



04214

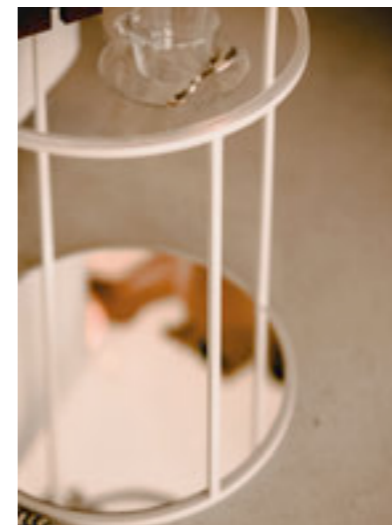

04212

079 SEA SIDE – COFFEE TABLE

ITA Struttura portante in tubolare quadrato
in metallo 15 × 15 mm verniciata con ripiani in
cristallo acrilico trasparente spessore 15 mm.



**Geometric
and strong,
made to store
the things
you love.**

ENG Metal coated structure in square tube
15 × 15 mm with shelves in transparent acrylic
crystal 15 mm thickness.



083 SEA SIDE – LIBRERIA / BOOK CASE





04217



04217

087 SEA SIDE – LIBRERIA / BOOK CASE

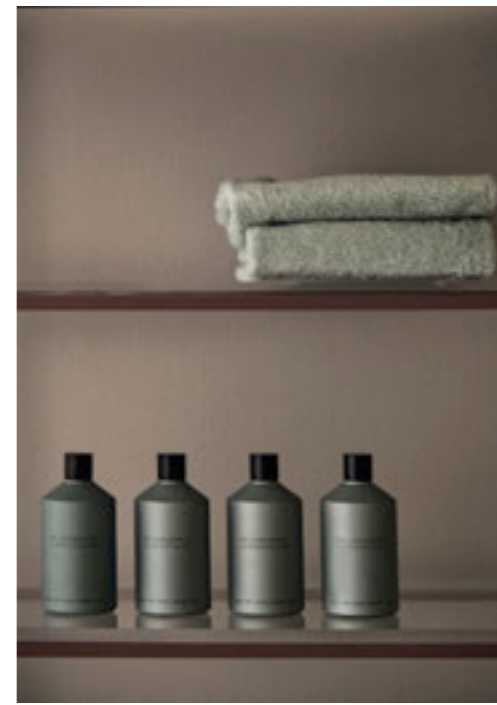

04217

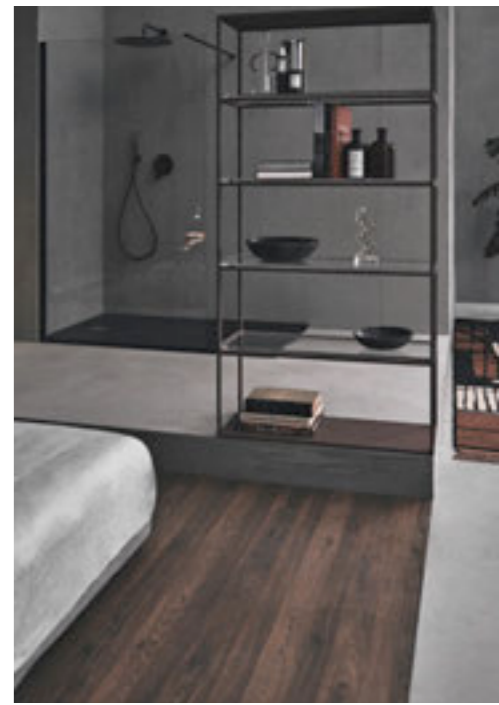

04217

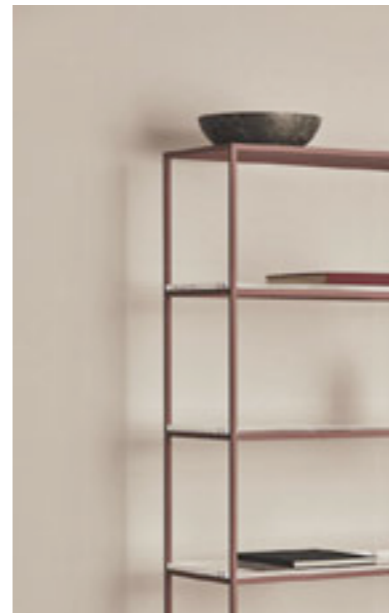

04217



ITA Struttura portante in tubolare quadrato
in metallo 15 × 15 mm verniciata con ripiani in
cristallo acrilico trasparente spessore 15 mm.



**style and sim-
plicity come
together to
help you work.**

L60

ENG Metal coated structure in square tube
15 × 15 mm with shelves in transparent acrylic
crystal 15 mm thickness.



04219



04219

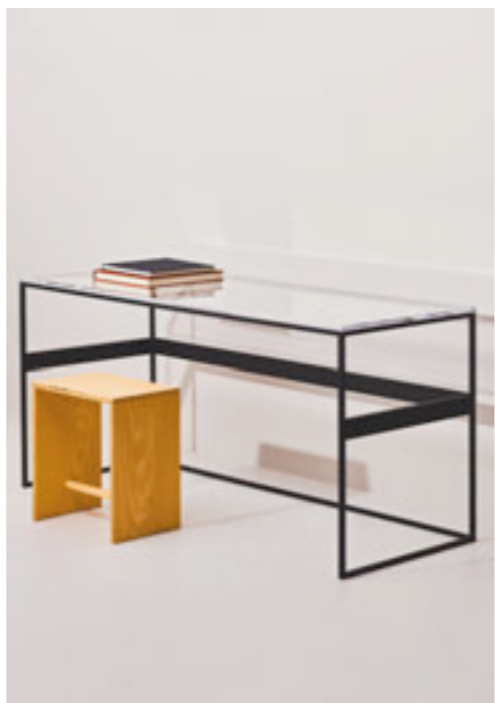

04219



04219

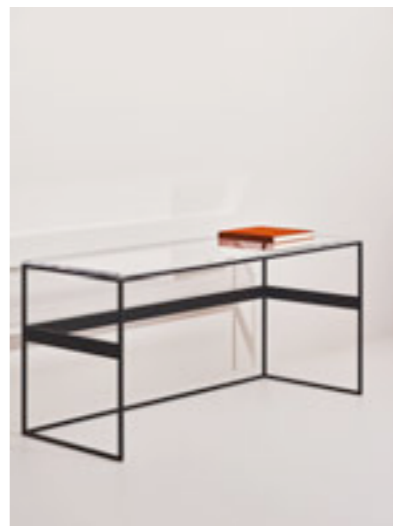

04219



04219

093 SEA SIDE – SCRIVANIA / DESK



095 SEA SIDE – SCRIVANIA / DESK

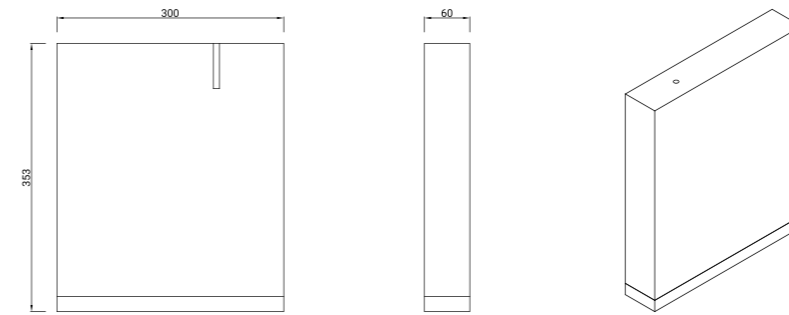

[CODICE: 08127]

EXPERIMENT E01 – LAMPADA DA TAVOLO / TABLE LAMP

Lampada da tavolo in cristallo acrilico

Potenza / Power	Max 5 W
Tensione / Voltage	24 V
Fonte Luminosa / Light Source	Strip-LED 8W – mt cool white
Materiali / Materials	Cristallo Acrilico Graflight / Graflight Acrylic Crystal
Finiture / Finishes	E0 Graflight
Certificazioni	CE □

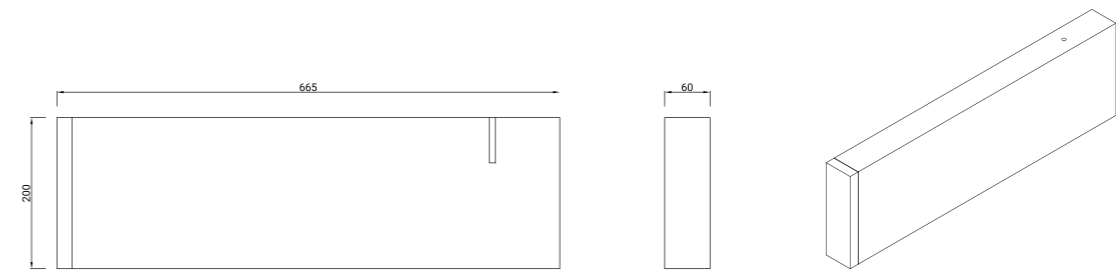

[CODICE: 08148]

EXPERIMENT E02 – LAMPADA DA TAVOLO / TABLE LAMP

Lampada da tavolo in cristallo acrilico

Potenza / Power	Max 5 W
Tensione / Voltage	24 V
Fonte Luminosa / Light Source	Strip-LED 8W – mt cool white
Materiali / Materials	Cristallo Acrilico Graflight / Graflight Acrylic Crystal
Finiture / Finishes	E0 Graflight
Certificazioni	CE □

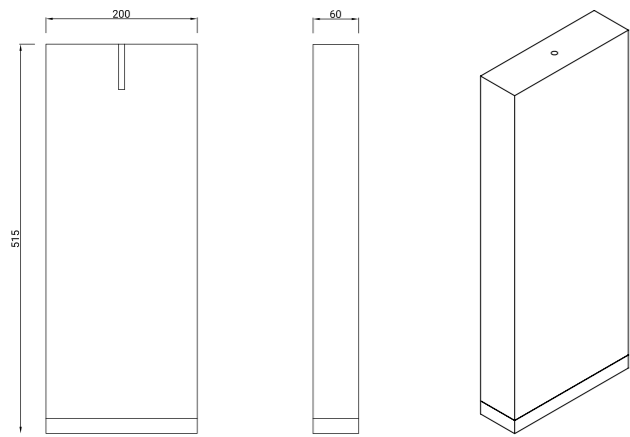

[CODICE: 08149]

EXPERIMENT E03 – LAMPADA DA TAVOLO / TABLE LAMP

Lampada da tavolo in cristallo acrilico

Potenza / Power	Max 5 W
Tensione / Voltage	24 V
Fonte Luminosa / Light Source	Strip-LED 8W – mt cool white
Materiali / Materials	Cristallo Acrilico Graflight / Graflight Acrylic Crystal
Finiture / Finishes	E0 Graflight
Certificazioni	CE <input type="checkbox"/>

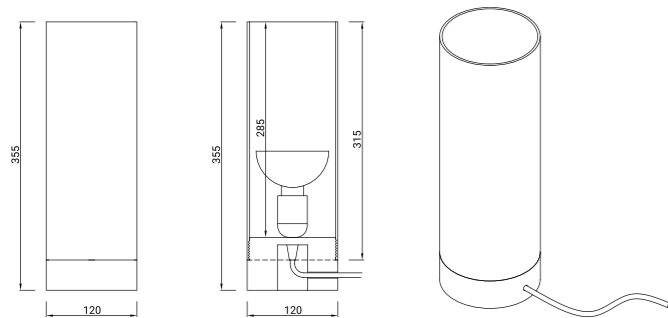

[CODICE: 08120]

FARETTO – LAMPADA DA TAVOLO / TABLE LAMP

Lampada da tavolo in metallo verniciato con diffusore e base in cristallo acrilico

Potenza / Power	15 W
Tensione / Voltage	220 – 240 V
Fonte Luminosa / Light Source *	Lampadina LED E27 / LED Bulb E27
Materiali / Materials	Metallo / Metal
Finiture / Finishes	Opaca / Matt 10 ●
Certificazioni	CE <input type="checkbox"/>

* fonte luminosa esclusa – light source excluded

099

INFORMAZIONI TECNICHE / TECHNICAL INFORMATION

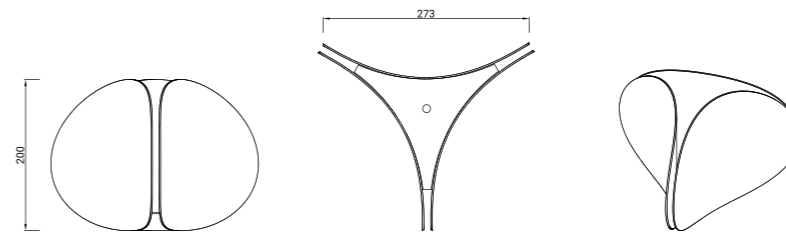

[CODICE: 08140]

FLIP SMALL – LAMPADA DA TAVOLO / TABLE LAMP

Lampada da tavolo in cristallo acrilico o acciaio inox

Potenza / Power	Max 75 W
Tensione / Voltage	220 – 240 V
Fonte Luminosa / Light Source *	1 Lampadina LED / 1 LED Bulb 19W E27
Materiali / Materials	Acciaio Inox Super Mirror / Super Mirror Stainless (Lucida / Glossy) 56 ● 66 ●
	Acciaio Inox Super Mirror / Super Mirror Stainless (Opaca / Matt) 30 ○
	Cristallo Acrilico / Acrylic Crystal (Opaca / Matt) 05 ●
Certificazioni	CE <input type="checkbox"/>

* fonte luminosa esclusa – light source excluded

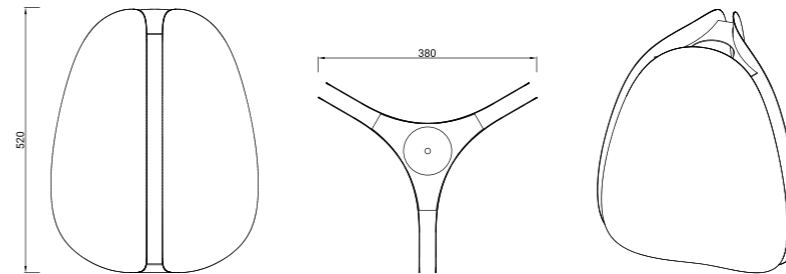

[CODICE: 08141]

FLIP MEDIUM – LAMPADA DA TAVOLO / TABLE LAMP

Lampada da tavolo in cristallo acrilico o acciaio inox

Potenza / Power	max 100 W
Tensione / Voltage	220 – 240 V
Fonte Luminosa / Light Source *	1 Lampadina LED / 1 LED Bulb 19W E27
Materiali / Materials	Acciaio Inox Super Mirror / Super Mirror Stainless (Lucida / Glossy) 56 ● 66 ●
	Acciaio Inox Super Mirror / Super Mirror Stainless (Opaca / Matt) 30 ○
	Cristallo Acrilico / Acrylic Crystal (Opaca / Matt) 05 ●
Certificazioni	CE <input type="checkbox"/>

* fonte luminosa esclusa – light source excluded

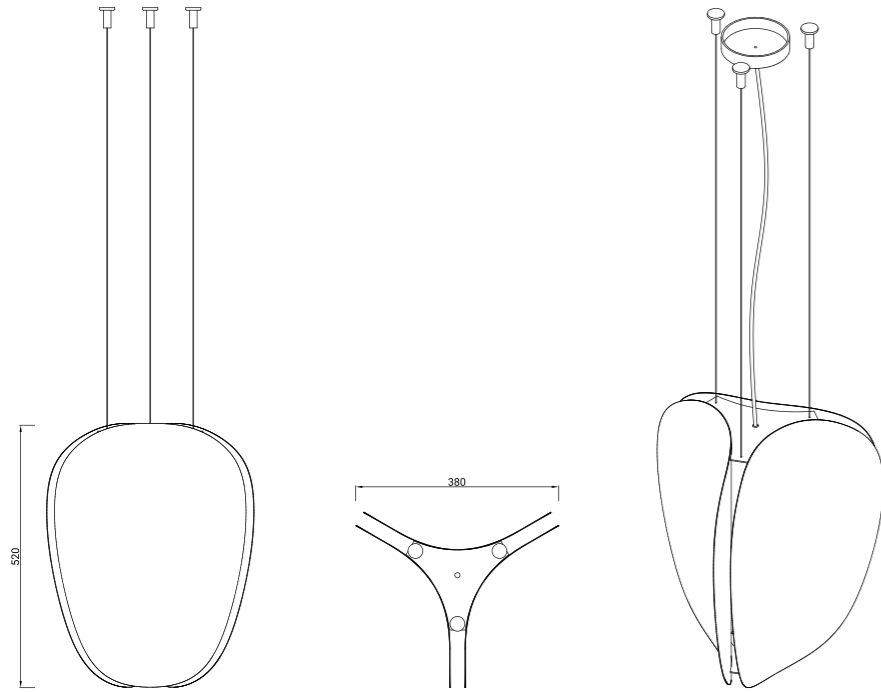

[CODICE: 08145]

FLIP MEDIUM – LAMPADA A SOSPENSIONE / SUSPENSION LAMP

Lampada da tavolo in cristallo acrilico o acciaio inox

Potenza / Power	Max 100 W		
Tensione / Voltage	220 – 240 V		
Fonte Luminosa / Light Source *	1 Lampadina LED / 1 LED Bulb 19W E27		
Materiali / Materials	Acciaio Inox Super Mirror / Super Mirror Stainless (Lucida / Glossy)	56 ●	66 ●
	Acciaio Inox Super Mirror / Super Mirror Stainless (Lucida / Glossy)	30 ○	
	Cristallo Acrilico / Acrylic Crystal (Opaca / Matt)	05 ●	
Certificazioni	CE □		

* fonte luminosa esclusa — light source excluded

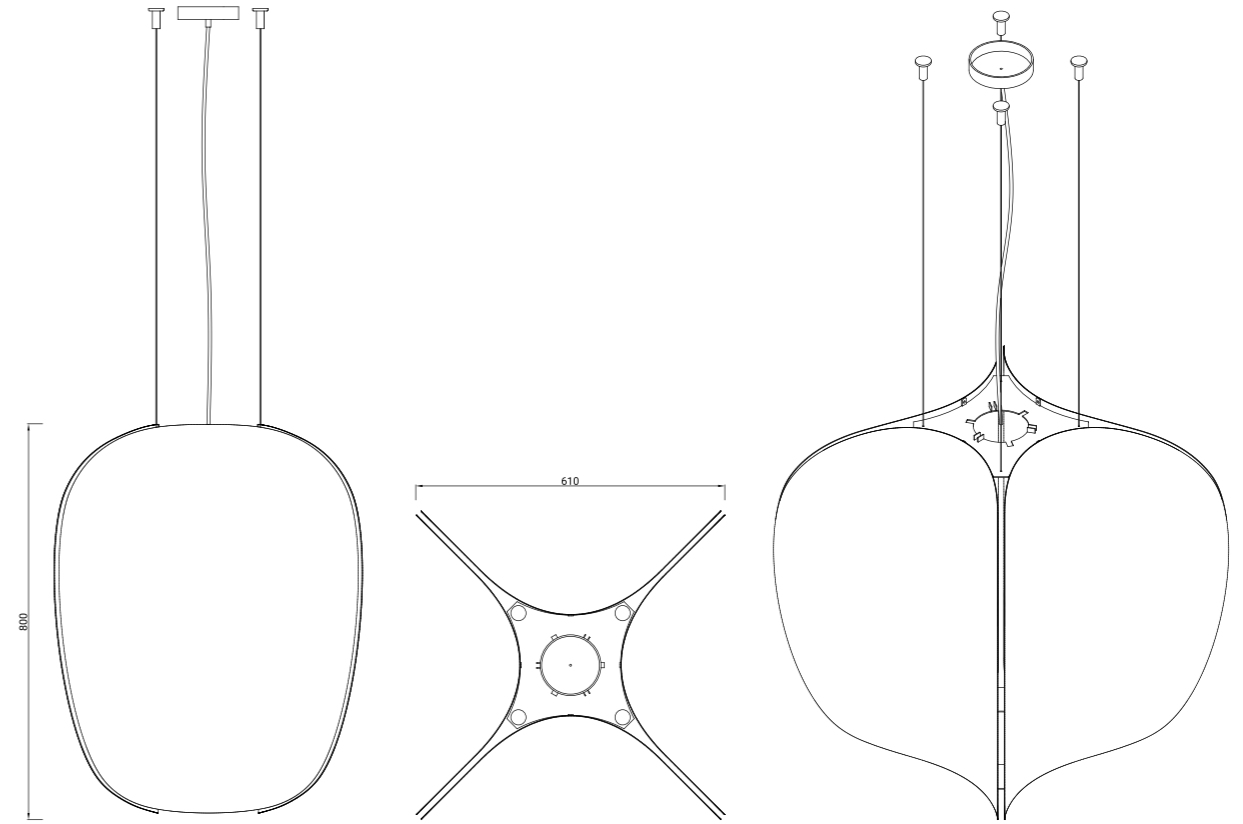

[CODICE: 08142]

FLIP LARGE – LAMPADA A SOSPENSIONE / SUSPENSION LAMP

Lampada a sospensione in acciaio inox

Potenza / Power	Max 100 W		
Tensione / Voltage	220 – 240 V		
Fonte Luminosa / Light Source	2 Tubi LED / 2 LED Tubes 8.5W G13 830 lm 3000°K + 1 faretto LED / 1 LED Spotlight GU 10 530 lm		
Materiali / Materials	Acciaio Inox Super Mirror / Super Mirror Stainless (Lucida / Glossy)	56 ●	66 ●
	Acciaio Inox Super Mirror / Super Mirror Stainless (Opaca / Matt)	30 ○	
Certificazioni	CE □		

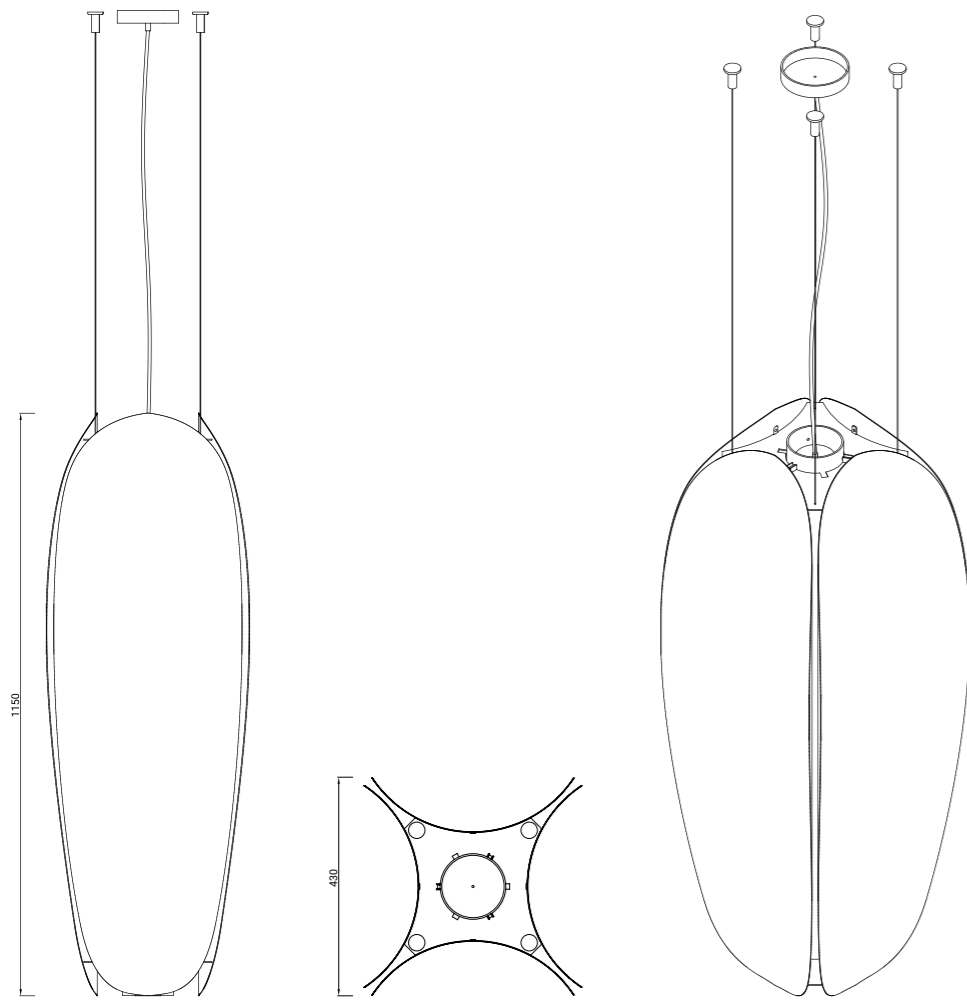

[CODICE: 08143]

FLIP EXTRA LARGE – LAMPADA A SOSPENSIONE / SUSPENSION LAMP

Lampada a sospensione in acciaio inox

Potenza / Power	Max 100 W		
Tensione / Voltage	220 – 240 V		
Fonte Luminosa / Light Source	2 Tubi LED / 2 LED Tubes 8.5W lm G13 830 lm 3000°K + 1 faretto LED / 1 LED Spotlight 7W GU10 530 lm		
Materiali / Materials	Acciaio Inox Super Mirror / Super Mirror Stainless (Lucida / Glossy)	56 ●	66 ●
	Acciaio Inox Super Mirror / Super Mirror Stainless (Opaca / Matt)	30 ○	
Certificazioni	CE □		

0102

0103 INFORMAZIONI TECNICHE / TECHNICAL INFORMATION

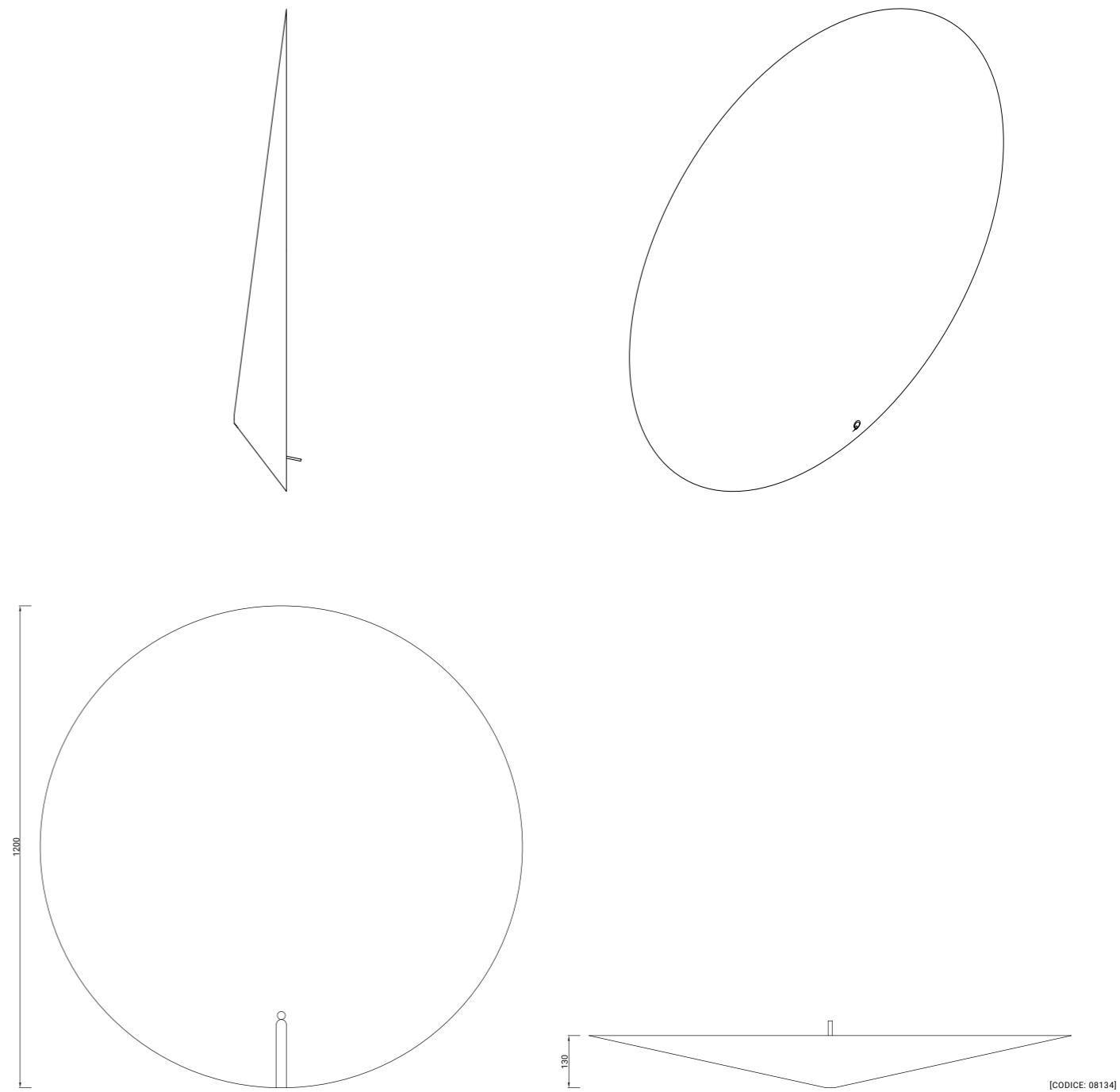

[CODICE: 08134]

GONG GRANDE / GONG LARGE – LAMPADA DA PARETE / WALL LAMP

Lampada a parete in acciaio inox

Potenza / Power	Max 100 W						
Tensione / Voltage	220 – 240 V						
Fonte Luminosa / Light Source *	1 Lampadina LED / 1 LED Bulb 19W E27						
Materiali / Materials	Acciaio Inox Super Mirror / Super Mirror Stainless Steel						
Finiture / Finishes	Opaca / Matt	10 ●	30 ○	48 ●	94 ●	96 ●	97 ●
	Lucida / Glossy	56 ●	66 ●				
Certificazioni	CE □						

* fonte luminosa esclusa – light source excluded

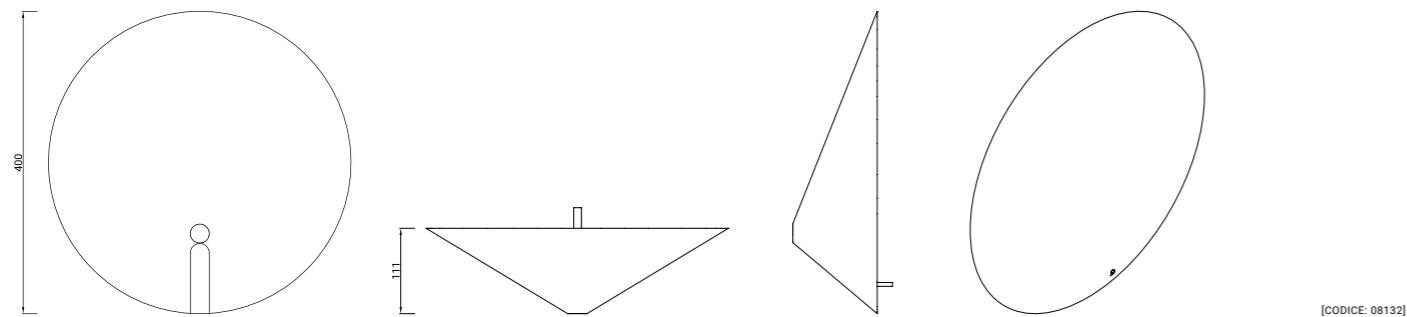

[CODICE: 08132]

GONG TONDO PICCOLA / GONG ROUND SMALL – LAMPADA DA PARETE / WALL LAMP

Lampada a parete in acciaio inox

Potenza / Power	Max 100 W						
Tensione / Voltage	220 – 240 V						
Fonte Luminosa / Light Source *	1 Lampadina LED / 1 LED Bulb 19W 2500lm 2700°K						
Materiali / Materials	Acciaio Inox Super Mirror / Super Mirror Stainless Steel						
Finiture / Finishes	Opaca / Matt	10 ●	30 ○	48 ●	94 ●	96 ●	97 ●
	Lucida / Glossy	56 ●	66 ●				
Certificazioni	CE □						

* fonte luminosa esclusa – light source excluded

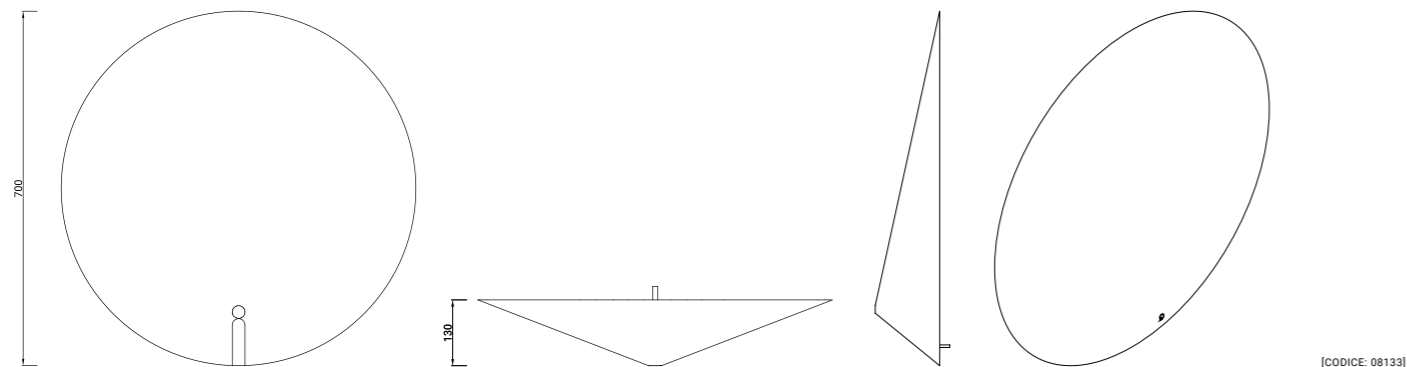

[CODICE: 08133]

GONG TONDO MEDIA / GONG ROUND MEDIUM – LAMPADA DA PARETE / WALL LAMP

Lampada a parete in acciaio inox

Potenza / Power	Max 100 W						
Tensione / Voltage	220 – 240 V						
Fonte Luminosa / Light Source *	1 Lampadina LED / 1 LED Bulb 19W 2500lm 2700°K						
Materiali / Materials	Acciaio Inox Super Mirror / Super Mirror Stainless Steel						
Finiture / Finishes	Opaca / Matt	10 ●	30 ○	48 ●	94 ●	96 ●	97 ●
	Lucida / Glossy	56 ●	66 ●				
Certificazioni	CE □						

* fonte luminosa esclusa – light source excluded

0105 INFORMAZIONI TECNICHE / TECHNICAL INFORMATION

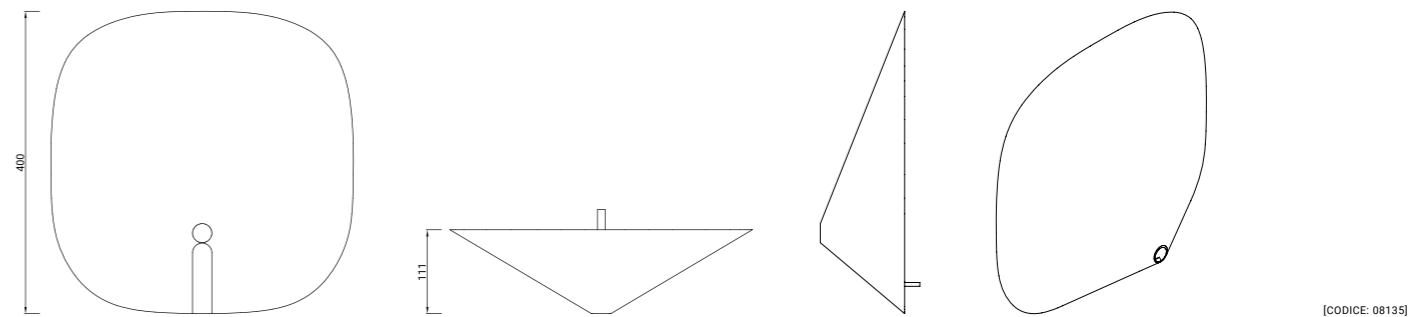

[CODICE: 08135]

GONG QUADRATA PICCOLA / GONG SQUARE SMALL – LAMPADA DA PARETE / WALL LAMP

Lampada a parete in acciaio inox

Potenza / Power	Max 100 W						
Tensione / Voltage	220 – 240 V						
Fonte Luminosa / Light Source *	1 Lampadina LED / 1 LED Bulb 19W 2500lm 2700°K						
Materiali / Materials	Acciaio Inox Super Mirror / Super Mirror Stainless Steel						
Finiture / Finishes	Opaca / Matt	10 ●	30 ○	48 ●	94 ●	96 ●	97 ●
	Lucida / Glossy	56 ●	66 ●				
Certificazioni	CE □						

* fonte luminosa esclusa – light source excluded

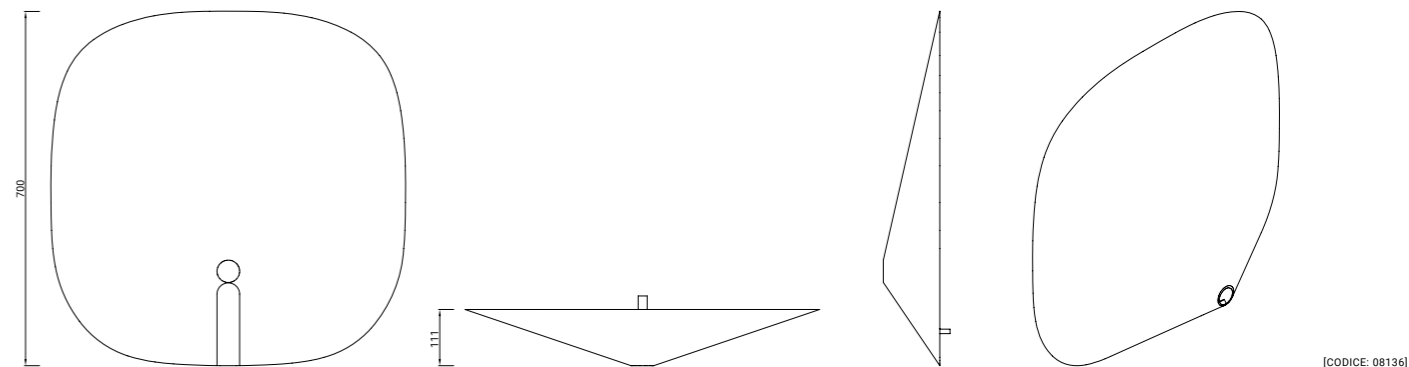

[CODICE: 08136]

GONG QUADRATA MEDIA / GONG SQUARE MEDIUM – LAMPADA DA PARETE / WALL LAMP

Lampada a parete in acciaio inox

Potenza / Power	Max 100 W						
Tensione / Voltage	220 – 240 V						
Fonte Luminosa / Light Source *	1 Lampadina LED / 1 LED Bulb 19W 2500lm 2700°K						
Materiali / Materials	Acciaio Inox Super Mirror / Super Mirror Stainless Steel						
Finiture / Finishes	Opaca / Matt	10 ●	30 ○	48 ●	94 ●	96 ●	97 ●
	Lucida / Glossy	56 ●	66 ●				
Certificazioni	CE □						

* fonte luminosa esclusa – light source excluded

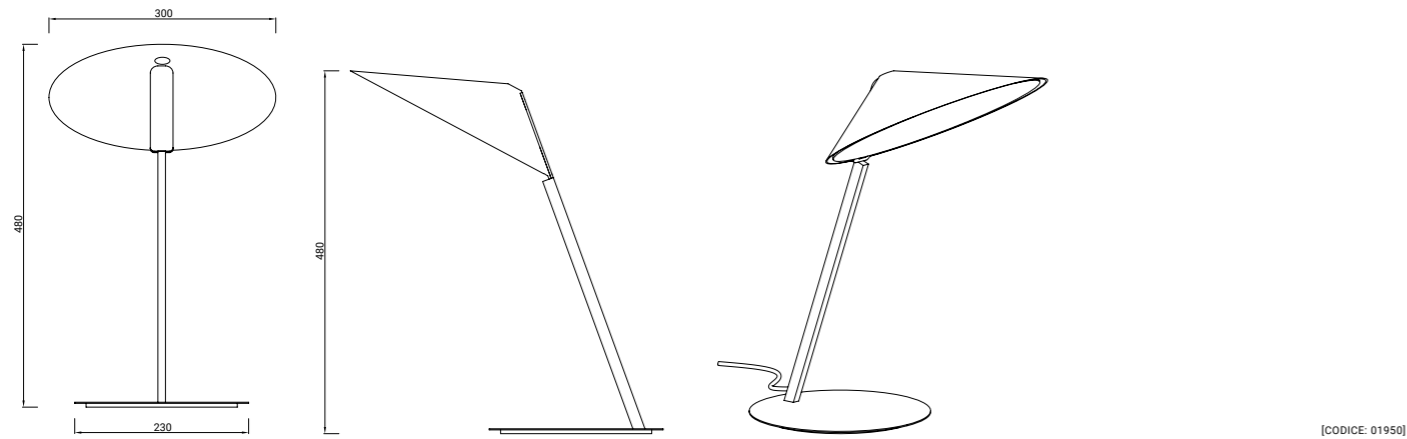

[CODICE: 01950]

GONG WORK – LAMPADA DA TAVOLO / TABLE LAMP

Lampada da tavolo in metallo verniciato con diffusore in policarbonato opalino monosabbiato

Potenza / Power	Max 5 W						
Tensione / Voltage	220 – 240 V						
Fonte Luminosa / Light Source	1 lampadina LED / 1 LED Bulb 5W G9						
Materiali / Materials	Metallo / Metal						
Finiture / Finishes	Opaca / Matt	10 ●	30 ○	48 ●	94 ●	96 ●	97 ●
Certificazioni	CE	□					

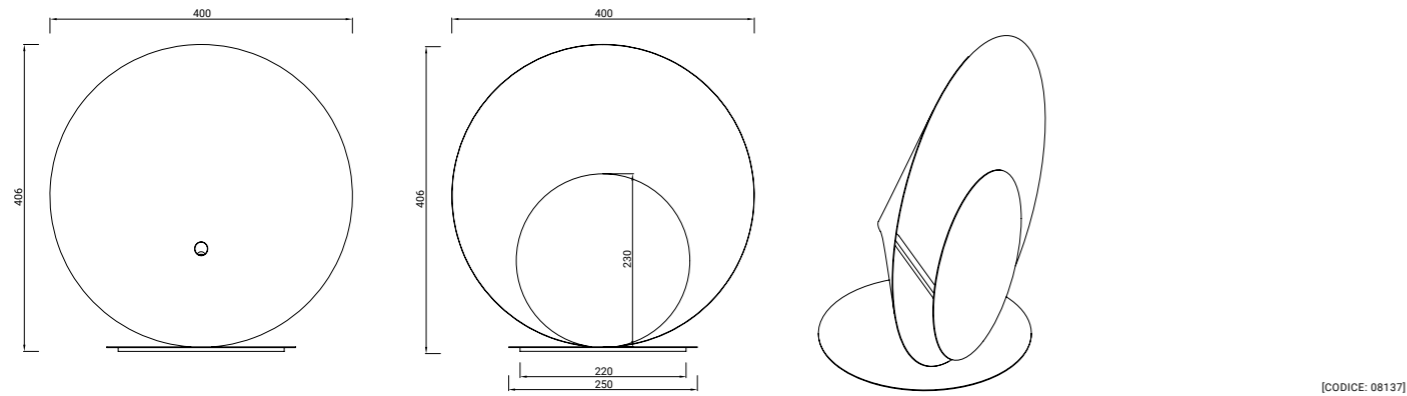

[CODICE: 08137]

GONG – LAMPADA DA TAVOLO / TABLE LAMP

Lampada da tavolo in metallo verniciato con diffusore e base in acciaio super mirror

Potenza / Power	7,5 W						
Tensione / Voltage	220 – 240 V						
Fonte Luminosa / Light Source *	Bulbo Led E14 / Led Bulb E14						
Materiali / Materials	Metallo / Metal						
Finiture / Finishes	Opaca / Matt	10 ●	30 ○	48 ●	94 ●	96 ●	97 ●
	Lucida / Glossy	56 ●	66 ●				
Certificazioni	CE	□					

* fonte luminosa esclusa – light source excluded

0107 INFORMAZIONI TECNICHE / TECHNICAL INFORMATION

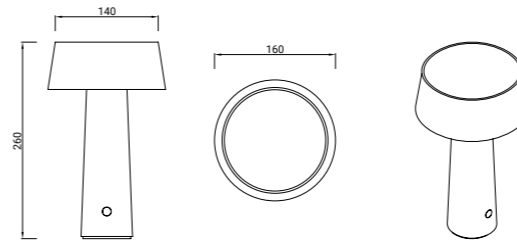

[CODICE: 01945]

MUSH – LAMPADA DA TAVOLO / TABLE LAMP

Lampada da tavolo in ABS verniciato con diffusore in policarbonato opalino monosabbiato

Potenza / Power	Max 5 W battery					
Tensione / Voltage	5 V					
Fonte Luminosa / Light Source	modulo 36 led 3W 200lm 3000°K					
Materiali / Materials	ABS					
Finiture / Finishes	Opaca / Matt	10 ●	30 ○	20 ●	32 ●	81 ●
	Lucida / Glossy	56 ●	66 ●			
Certificazioni	IP 63	CE	□			

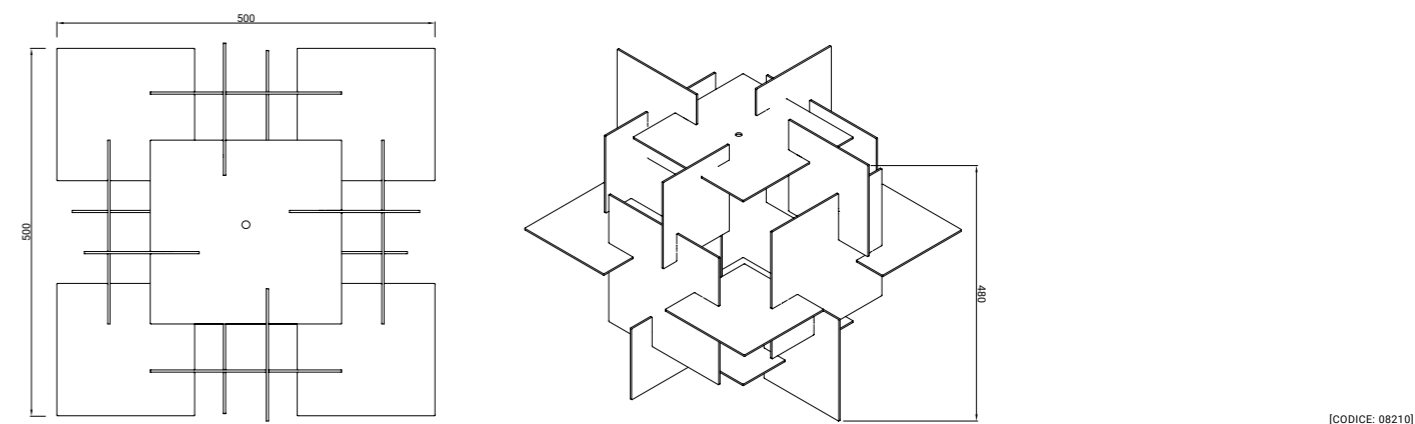

[CODICE: 08210]

NEXT – LAMPADA A SOSPENSIONE / SUSPENSION LAMP

Lampada a sospensione in cristallo acrilico

Potenza / Power	Max 15 W			
Tensione / Voltage	220 – 240 V			
Fonte Luminosa / Light Source *	1 Lampadina LED / 1 LED Bulb E27			
Materiali / Materials	Cristallo Acrilico / Acrylic Crystal			
Finiture / Finishes	Opaca / Matt	00 ●	05 ●	
	Lucida / Glossy	56 ●		
Certificazioni	CE	□		

* fonte luminosa esclusa – light source excluded

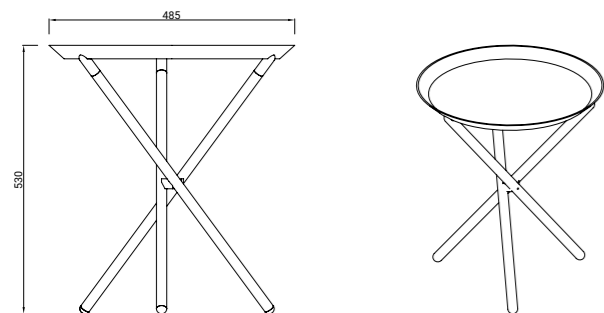

[CODICE: 102]

MARRAKECH MEDIO ALTO / MARRAKECH MEDIUM HIGH – COFFEE TABLE

Tavolino con vassoio in metallo verniciato e stampato con gambe in metallo verniciato o in cristallo acrilico trasparente

Materiali / Materials	Metallo, Cristallo Acrilico / Metal, Acrylic Crystal							
Varianti Gambe / Leg Variations	Metallo Verniciato	10 ●	30 ○	48 ●	94 ●	96 ●	97 ●	
	Plexiglass	00 ●						
Varianti Vassoi / Tray Variations	Metallo Verniciato	10 ●	30 ○	48 ●	94 ●	96 ●	97 ●	
	Lines & Stripes	01 ^{LS} ●	02 ^{LS} ●	03 ^{LS} ●	04 ^{LS} ●			
	Flower & Power	01 ^{FP} ●	02 ^{FP} ●	03 ^{FP} ●	04 ^{FP} ●	05 ^{FP} ●	06 ^{FP} ●	07 ^{FP} ●
	Certificazioni	CE	□					

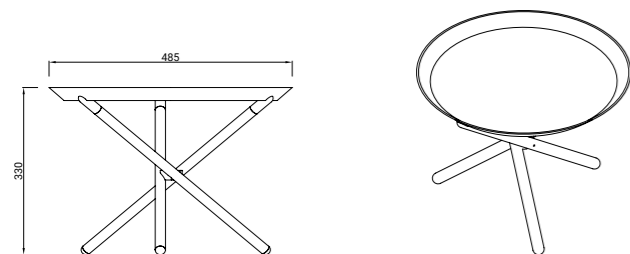

[CODICE: 103]

MARRAKECH MEDIO BASSO / MARRAKECH MEDIUM LOW – COFFEE TABLE

Tavolino con vassoio in metallo verniciato e stampato con gambe in metallo verniciato o in cristallo acrilico trasparente

Materiali / Materials	Metallo, Cristallo Acrilico / Metal, Acrylic Crystal							
Varianti Gambe / Leg Variations	Metallo Verniciato	10 ●	30 ○	48 ●	94 ●	96 ●	97 ●	
	Plexiglass	00 ●						
Varianti Vassoi / Tray Variations	Metallo Verniciato	10 ●	30 ○	48 ●	94 ●	96 ●	97 ●	
	Lines & Stripes	01 ^{LS} ●	02 ^{LS} ●	03 ^{LS} ●	04 ^{LS} ●			
	Flower & Power	01 ^{FP} ●	02 ^{FP} ●	03 ^{FP} ●	04 ^{FP} ●	05 ^{FP} ●	06 ^{FP} ●	07 ^{FP} ●
	Certificazioni	CE	□					

0109 INFORMAZIONI TECNICHE / TECHNICAL INFORMATION

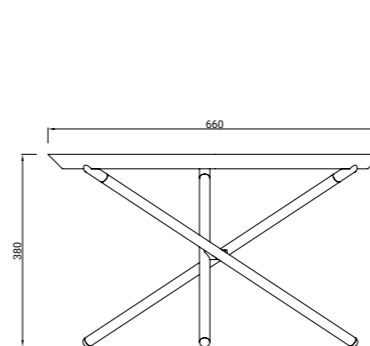

[CODICE: 104]

MARRAKECH GRANDE / MARRAKECH LARGE – COFFEE TABLE

Tavolino con vassoio in metallo verniciato e stampato con gambe in metallo verniciato o in cristallo acrilico trasparente

Materiali / Materials	Metallo, Cristallo Acrilico / Metal, Acrylic Crystal							
Varianti Gambe / Leg Variations	Metallo Verniciato	10 ●	30 ○	48 ●	94 ●	96 ●	97 ●	
	Plexiglass	00 ●						
Varianti Vassoi / Tray Variations	Metallo Verniciato	10 ●	30 ○	48 ●	94 ●	96 ●	97 ●	
	Lines & Stripes	01 ^{LS} ●	02 ^{LS} ●	03 ^{LS} ●	04 ^{LS} ●			
	Flower & Power	01 ^{FP} ●	02 ^{FP} ●	03 ^{FP} ●	04 ^{FP} ●	05 ^{FP} ●	06 ^{FP} ●	07 ^{FP} ●
	Certificazioni	CE	□					

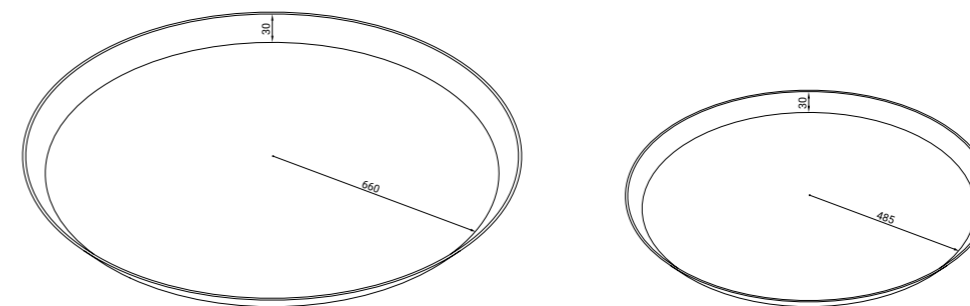

[CODICE: 018 DIAMETRO 66CM]
[CODICE: 019 DIAMETRO 48,5CM]

VASSOIO GRANDE E MEDIO / LARGE & MEDIUM TRAY

Vassoio in metallo verniciato e stampato

Materiali / Materials	Metallo / Metal							
Varianti Vassoi / Tray Variations	Metallo Verniciato	10 ●	30 ○	48 ●	94 ●	96 ●	97 ●	
	Lines & Stripes	01 ^{LS} ●	02 ^{LS} ●	03 ^{LS} ●	04 ^{LS} ●			
	Flower & Power	01 ^{FP} ●	02 ^{FP} ●	03 ^{FP} ●	04 ^{FP} ●	05 ^{FP} ●	06 ^{FP} ●	07 ^{FP} ●
Certificazioni	CE	□						

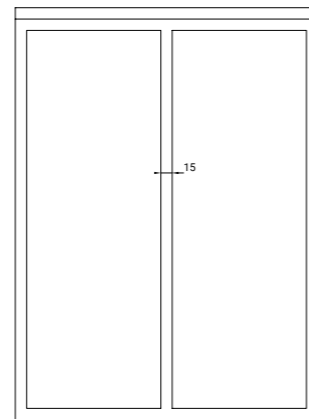
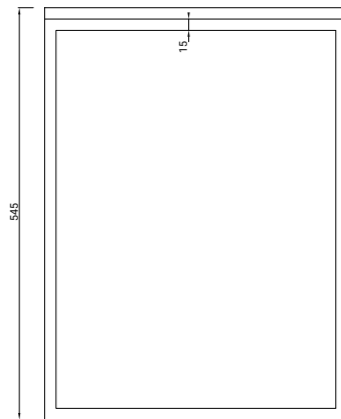
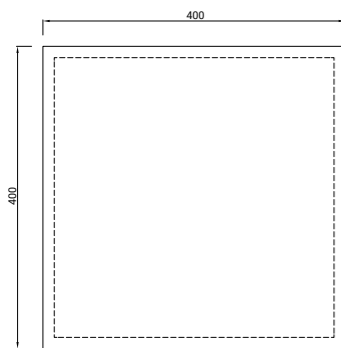
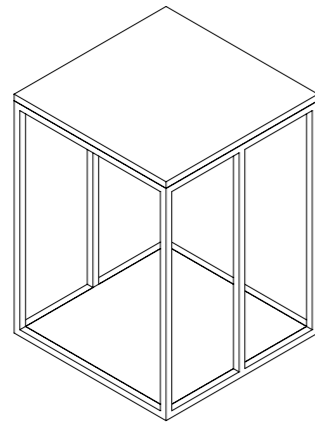

[CODICE: 04213]

SEA SIDE – COFFEE TABLE

Serie di arredi con struttura portante in tubolari di ferro verniciato con ripiani in cristallo acrilico trasparente

Struttura/ Structure	Tubolare di Ferro / Iron Bars 15 × 15 mm						
Vernice / Varnish	Verniciata a Polvere con Piano in Cristallo / Powder Coated with Glass Top						
Ripiani / Top	Acrilico Trasparente / Transparent Acrylic 10 mm						
Materiali / Materials	Cristallo Acrilico, Metallo / Acrylic Crystal, Metal						
Finiture / Finishes	Opaca / Matt	10 ●	30 ○	48 ●	94 ●	96 ●	97 ●
Certificazioni	CE						

0110

0111 INFORMAZIONI TECNICHE / TECHNICAL INFORMATION

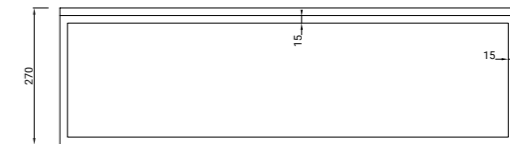
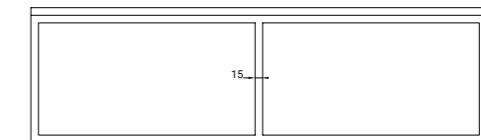
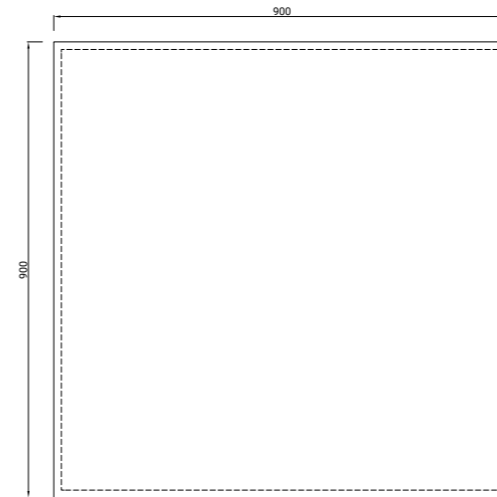
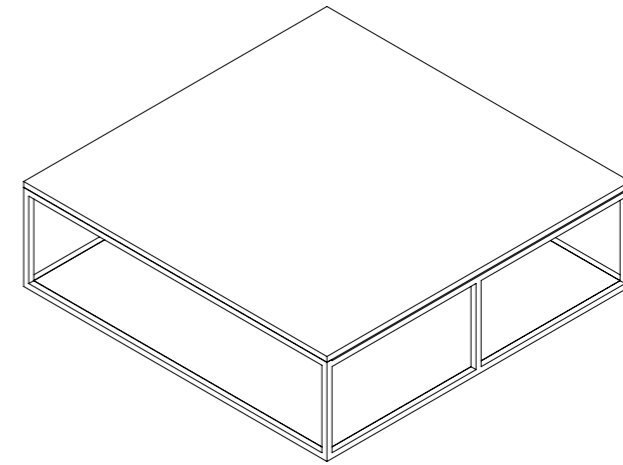

[CODICE: 04211]

SEA SIDE – COFFEE TABLE

Serie di arredi con struttura portante in tubolari di ferro verniciato con ripiani in cristallo acrilico trasparente

Struttura/ Structure	Tubolare di Ferro / Iron Bars 15 × 15 mm						
Vernice / Varnish	Verniciata a Polvere con Piano in Cristallo / Powder Coated with Glass Top						
Ripiani / Top	Acrilico Trasparente / Transparent Acrylic 10 mm						
Materiali / Materials	Cristallo Acrilico, Metallo / Acrylic Crystal, Metal						
Finiture / Finishes	Opaca / Matt	10 ●	30 ○	48 ●	94 ●	96 ●	97 ●
Certificazioni	CE						

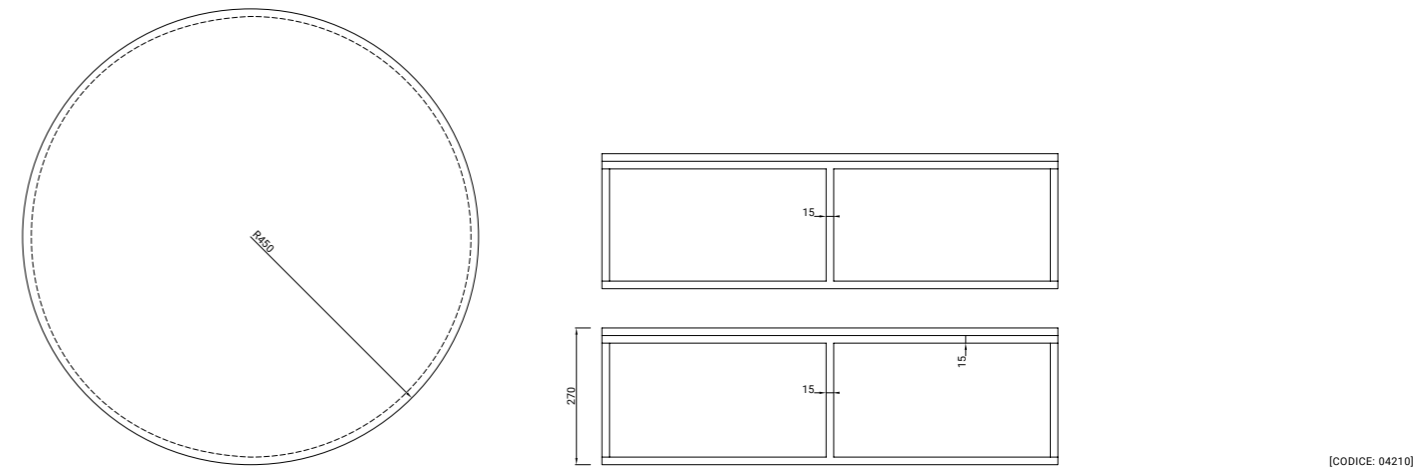
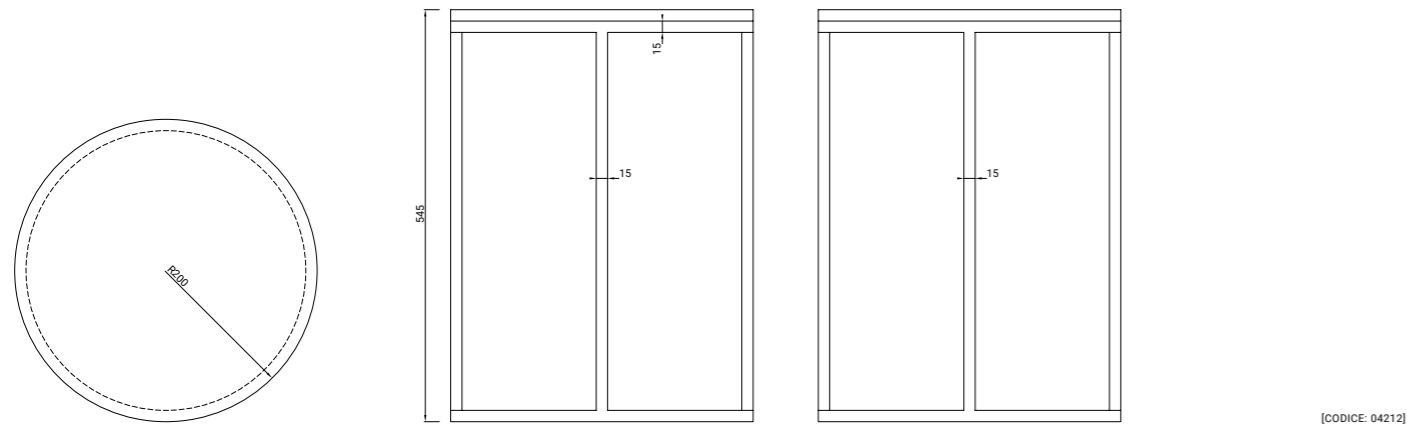
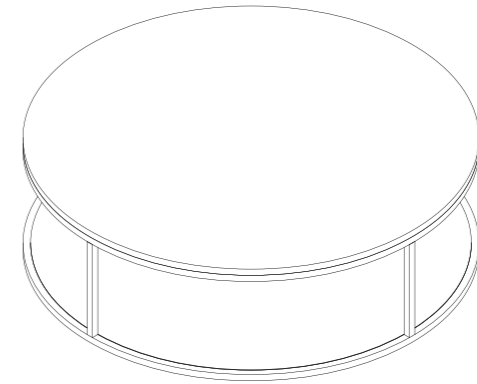
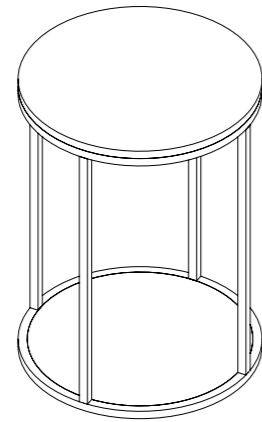

SEA SIDE – COFFEE TABLE

Serie di arredi con struttura portante in tubolari di ferro verniciato con ripiani in cristallo acrilico trasparente

Struttura/ Structure	Tubolare di Ferro / Iron Bars 15 × 15 mm						
Vernice / Varnish	Verniciata a Polvere con Piano in Cristallo / Powder Coated with Glass Top						
Ripiani / Top	Acrilico Trasparente / Transparent Acrylic 10 mm						
Materiali / Materials	Cristallo Acrilico, Metallo / Acrylic Crystal, Metal						
Finiture / Finishes	Opaca / Matt	10 ●	30 ○	48 ●	94 ●	96 ●	97 ●
Certificazioni	CE						

SEA SIDE – COFFEE TABLE

Serie di arredi con struttura portante in tubolari di ferro verniciato con ripiani in cristallo acrilico trasparente

Struttura/ Structure	Tubolare di Ferro / Iron Bars 15 × 15 mm						
Vernice / Varnish	Verniciata a Polvere con Piano in Cristallo / Powder Coated with Glass Top						
Ripiani / Top	Acrilico Trasparente / Transparent Acrylic 10 mm						
Materiali / Materials	Cristallo Acrilico, Metallo / Acrylic Crystal, Metal						
Finiture / Finishes	Opaca / Matt	10 ●	30 ○	48 ●	94 ●	96 ●	97 ●
Certificazioni	CE						

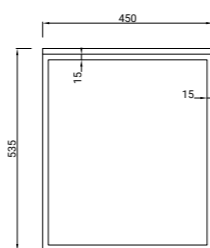
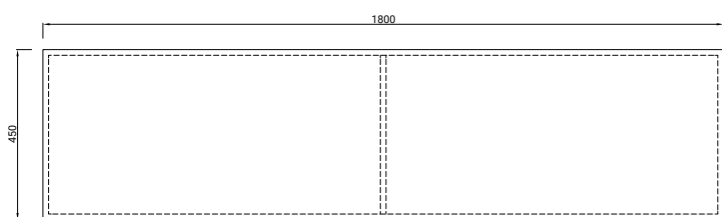
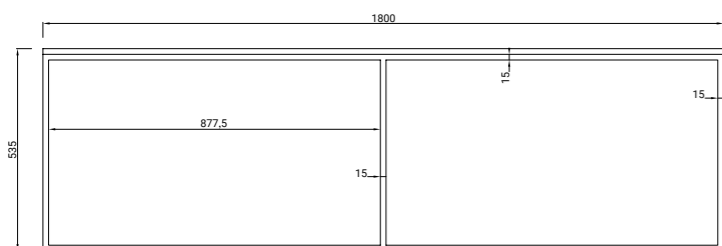
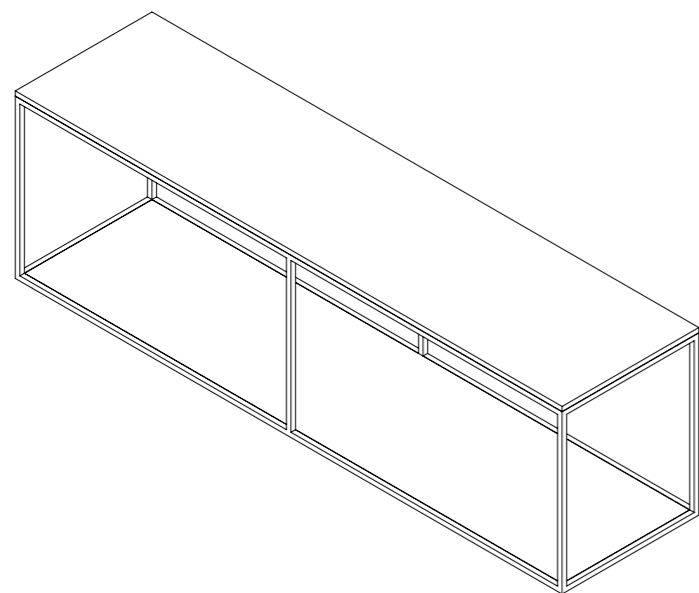

[CODICE: 04215]

SEA SIDE – CONSOLLE / CONSOLE

Serie di arredi con struttura portante in tubolari di ferro verniciato con ripiani in cristallo acrilico trasparente

Struttura/ Structure	Tubolare di Ferro / Iron Bars 15 × 15 mm						
Vernice / Varnish	Verniciata a Polvere con Piano in Cristallo / Powder Coated with Glass Top						
Ripiani / Top	Acrilico Trasparente / Transparent Acrylic 10 mm						
Materiali / Materials	Cristallo Acrilico, Metallo / Acrylic Crystal, Metal						
Finiture / Finishes	Opaca / Matt	10 ●	30 ○	48 ●	94 ●	96 ●	97 ●
Certificazioni	CE						

0115 INFORMAZIONI TECNICHE / TECHNICAL INFORMATION

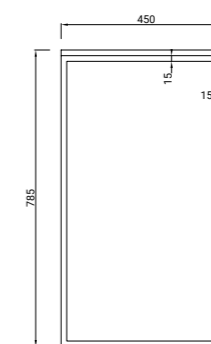
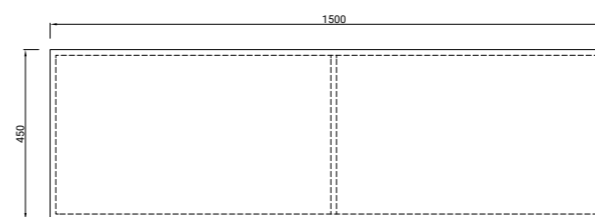
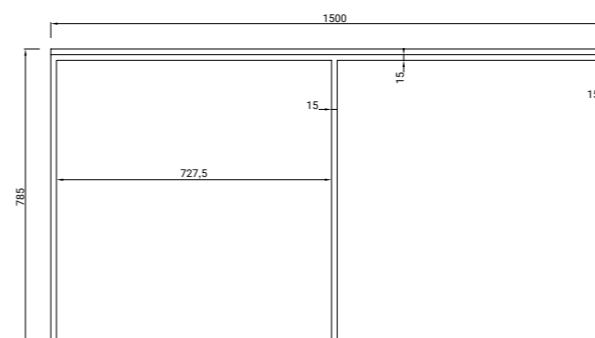
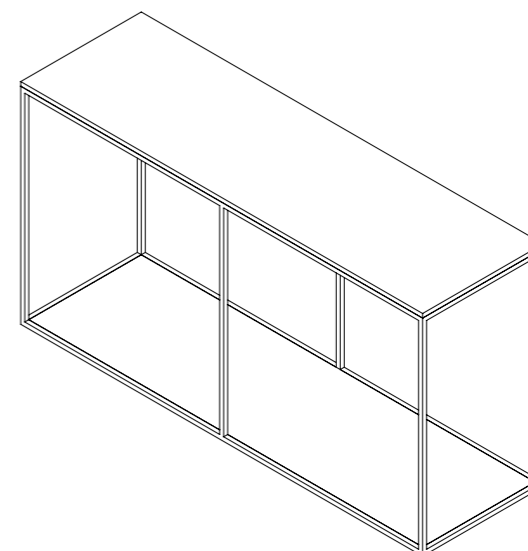

[CODICE: 04214]

SEA SIDE – CONSOLLE / CONSOLE

Serie di arredi con struttura portante in tubolari di ferro verniciato con ripiani in cristallo acrilico trasparente

Struttura/ Structure	Tubolare di Ferro / Iron Bars 15 × 15 mm						
Vernice / Varnish	Verniciata a Polvere con Piano in Cristallo / Powder Coated with Glass Top						
Ripiani / Top	Acrilico Trasparente / Transparent Acrylic 10 mm						
Materiali / Materials	Cristallo Acrilico, Metallo / Acrylic Crystal, Metal						
Finiture / Finishes	Opaca / Matt	10 ●	30 ○	48 ●	94 ●	96 ●	97 ●
Certificazioni	CE						

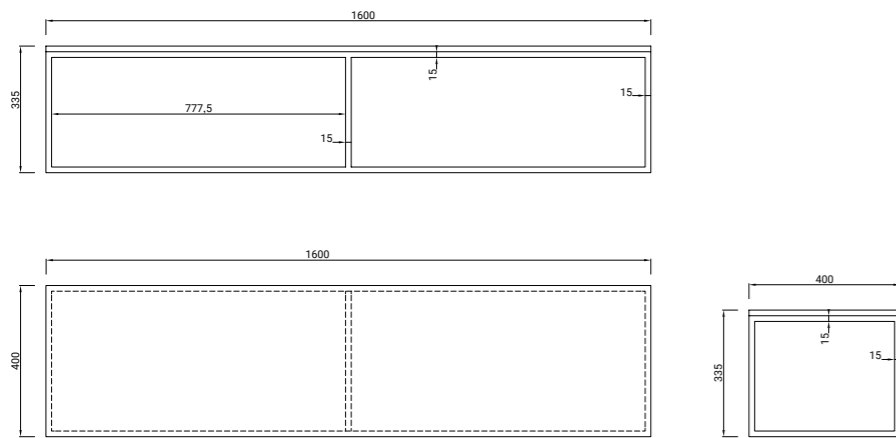
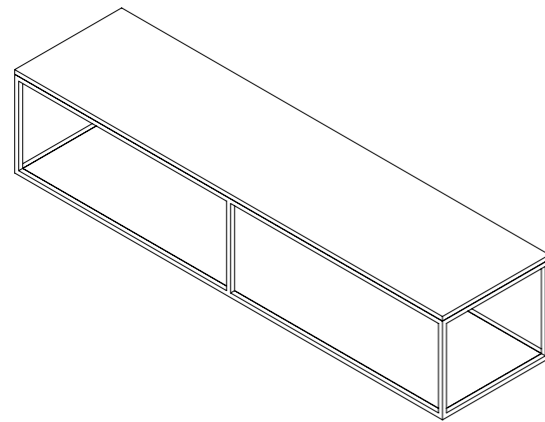

[CODICE: 04216]

SEA SIDE – PANCA / BENCH

Serie di arredi con struttura portante in tubolari di ferro verniciato con ripiani in cristallo acrilico trasparente

Struttura/ Structure	Tubolare di Ferro / Iron Bars 15 × 15 mm						
Vernice / Varnish	Verniciata a Polvere con Piano in Cristallo / Powder Coated with Glass Top						
Ripiani / Top	Acrilico Trasparente / Transparent Acrylic 10 mm						
Materiali / Materials	Cristallo Acrilico, Metallo / Acrylic Crystal, Metal						
Finiture / Finishes	Opaca / Matt	10 ●	30 ○	48 ●	94 ●	96 ●	97 ●
Certificazioni	CE						

0117 INFORMAZIONI TECNICHE / TECHNICAL INFORMATION

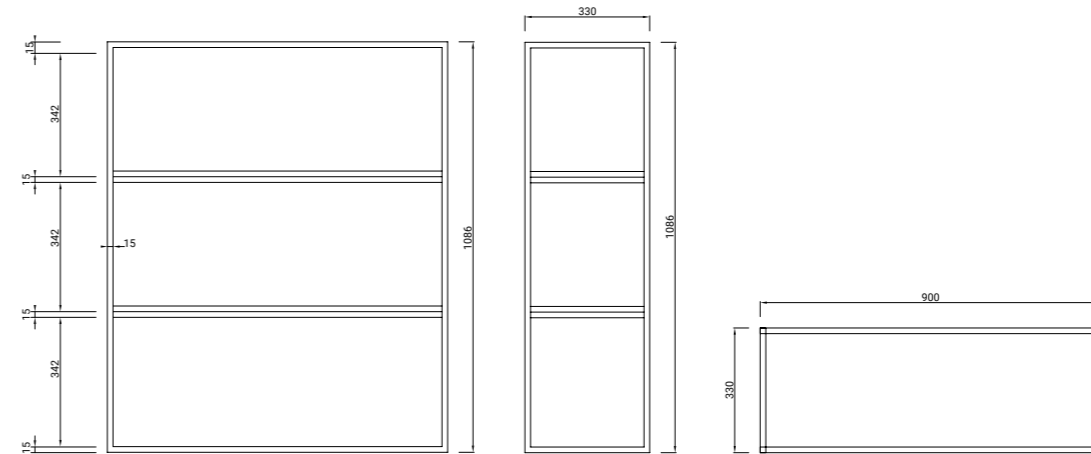
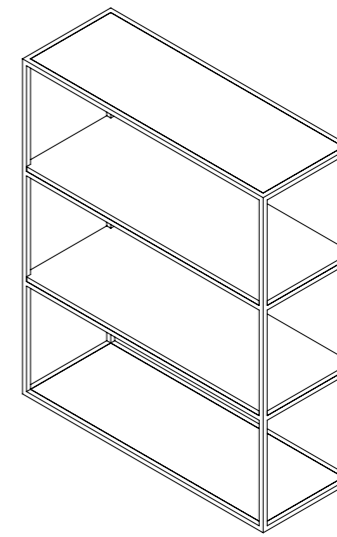

[CODICE: 04218]

SEA SIDE – LIBRERIA / BOOK CASE

Serie di arredi con struttura portante in tubolari di ferro verniciato con ripiani in cristallo acrilico trasparente

Struttura/ Structure	Tubolare di Ferro / Iron Bars 15 × 15 mm						
Vernice / Varnish	Verniciata a Polvere con Piano in Cristallo / Powder Coated with Glass Top						
Ripiani / Top	Acrilico Trasparente / Transparent Acrylic 10 mm						
Materiali / Materials	Cristallo Acrilico, Metallo / Acrylic Crystal, Metal						
Finiture / Finishes	Opaca / Matt	10 ●	30 ○	48 ●	94 ●	96 ●	97 ●
Certificazioni	CE						

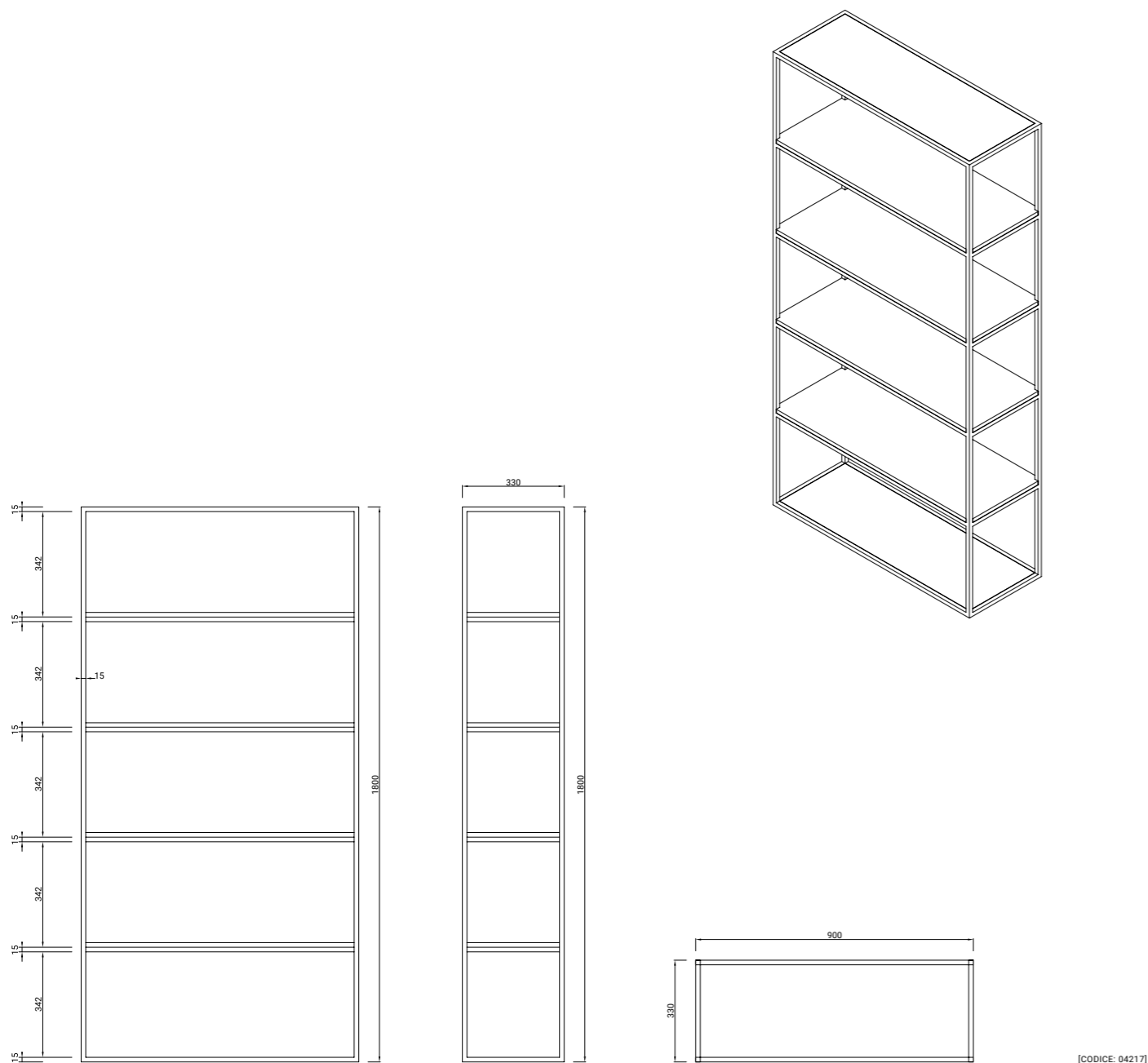

[CODICE: 04217]

SEA SIDE – LIBRERIA / BOOK CASE

Serie di arredi con struttura portante in tubolari di ferro verniciato con ripiani in cristallo acrilico trasparente

Struttura/ Structure	Tubolare di Ferro / Iron Bars 15 × 15 mm						
Vernice / Varnish	Verniciata a Polvere con Piano in Cristallo / Powder Coated with Glass Top						
Ripiani / Top	Acrilico Trasparente / Transparent Acrylic 10 mm						
Materiali / Materials	Cristallo Acrilico, Metallo / Acrylic Crystal, Metal						
Finiture / Finishes	Opaca / Matt	10 ●	30 ○	48 ●	94 ●	96 ●	97 ●
Certificazioni	CE						

0119 INFORMAZIONI TECNICHE / TECHNICAL INFORMATION

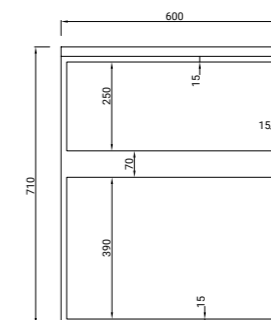
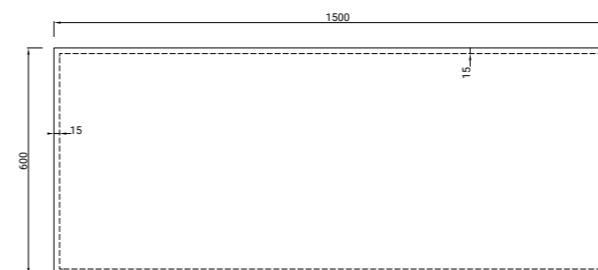
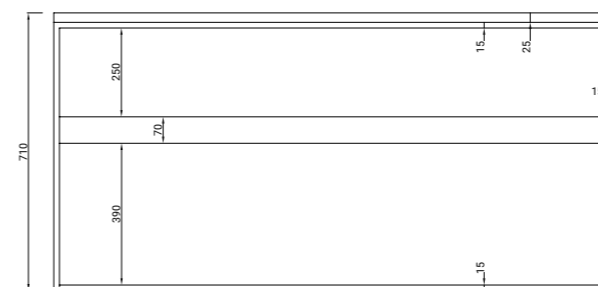
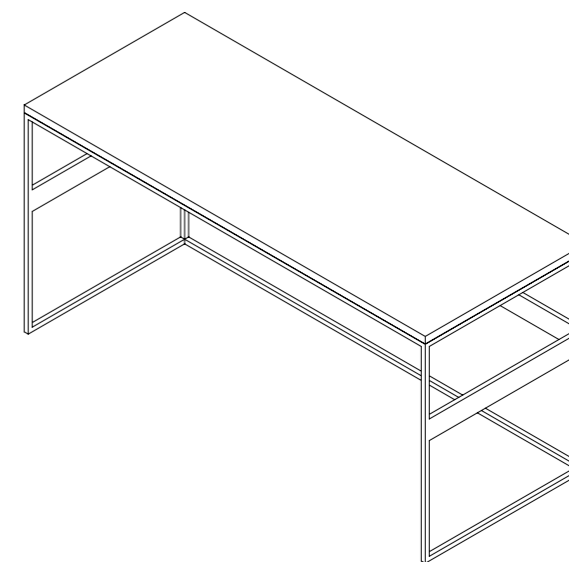

[CODICE: 04219]

SEA SIDE – SCRIVANIA / DESK

Serie di arredi con struttura portante in tubolari di ferro verniciato con ripiani in cristallo acrilico trasparente

Struttura/ Structure	Tubolare di Ferro / Iron Bars 15 × 15 mm						
Vernice / Varnish	Verniciata a Polvere con Piano in Cristallo / Powder Coated with Glass Top						
Ripiani / Top	Acrilico Trasparente / Transparent Acrylic 10 mm						
Materiali / Materials	Cristallo Acrilico, Metallo / Acrylic Crystal, Metal						
Finiture / Finishes	Opaca / Matt	10 ●	30 ○	48 ●	94 ●	96 ●	97 ●
Certificazioni	CE						

0121 MONOCOLORE / SINGLE COLOURS

VARIANTE COLORI / COLOUR VARIATIONS

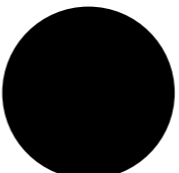

10 [NERO]

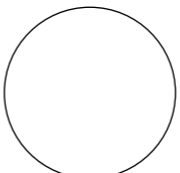

30 [BIANCO]

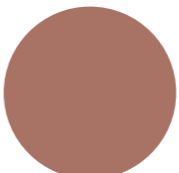

20 [CIPRIA]



32 [TORTORA]

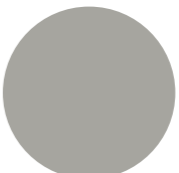

48 [GRIGIO]



81 [LIGHT GREEN]



94 [VINACCIA]

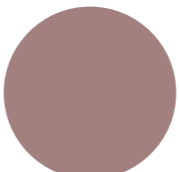

96 [COGNAC]

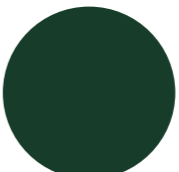

97 [VERDONE]

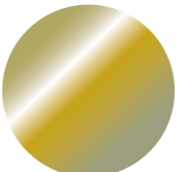

56 [ORO]

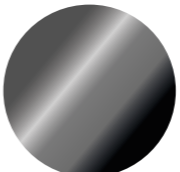

66 [CROMO]

LINES&STRIPES

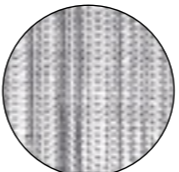

01LS



02LS



03LS

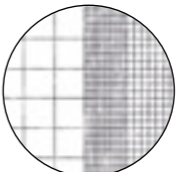

04LS

FLOWER&POWER

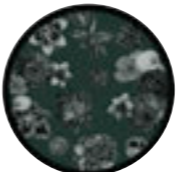

01FP



02FP



03FP



04FP



05FP



06FP



07FP



ITA Vesta ha un'esperienza trentennale nella progettazione e nella produzione di cristalli acrilici, sia per forniture conto terzi che per propria produzione.

La continua interazione con clienti prestigiosi e con tecnologie innovative ha permesso all'azienda di diventare un virtuoso esempio nella trasformazione della materia.

ENG Vesta has got thirty years of experience in designing and producing acrylic crystal, both for supplies to third parties and for its own production.

The continuous interaction with prestigious clients and innovative technologies allowed the company to become a virtuous example in transforming the material.



0124

0125 LUDOVICA + ROBERTO PALOMBA

ITA Ludovica + Roberto Palomba fondano Palomba Serafini Associati nel 1994.

Il segno distintivo dello studio emerge dalla capacità dei fondatori, di coniugare una visione contemporanea della società e delle esigenze delle persone, con un'ampia conoscenza delle radici storiche e culturali dell'architettura e del design, producendo risultati che fondono il passato con il futuro.

Questo approccio unico e personale rende la realtà di Palomba Serafini Associati, particolarmente sensibile alle questioni relative alla funzione e alla necessità di creare prodotti e architetture di lunga durata.

Lo studio nei suoi 25 anni di attività ha ricevuto numerosi premi internazionali come Compasso D'Oro, Elle Decoration International Design Award, l'Ahead Award, Red Dot, Design Plus, Good Design Award, German Design Award.

ENG Ludovica + Roberto Palomba founded Palomba Serafini Associates in 1994.

The hallmark of the studio merges from the founders' ability to combine a contemporary vision of society and people's needs, with a broad knowledge of the historical and cultural roots of architecture and design, producing results that blend the past with the future.

This unique and personal approach makes Palomba Serafini Associati's reality particularly sensitive to questions related to the function and the need to create long-lasting products and architectures.

In its 25 years of activity, the studio has received numerous international awards such as Compasso D'Oro, Elle Decoration International Design Award, Ahead Award, Red Dot, Design Plus, Good Design Award, German Design Award.

Art Direction	PS+a
Photography	Carlo William Rossi + Fabio Murredu
Locations	Tommaso Calabro Gallery Sardi Sale Posa Milan Private Home
Companies	Aquanova Argentum Boffi CC-Tapis Driade Horm Ideal Standard Knoll Redaelli Skin First Society Limonta Sort of Coal Vitra Wall & Decò Zanat Zanotta
Print	Fontgrafica Lab S.r.l.

VESTA srl
via Jesina 56/A
60022 Castelfidardo (AN)

+39 071.7202227

www.vesta.design

 [vesta.design_official](https://www.instagram.com/vesta.design_official)

 [vestainnovatedesign](https://www.facebook.com/vestainnovatedesign)

www.vesta.design

